

BOCCHI[®]

FOR EVERY SHADE OF YOU

KITCHEN



BATHROOM



PRICE LIST





BOCCHI[®]
PRICE LIST

TABLE OF CONTENTS



08 BOCCHI
TECHNOLOGY &
COLORS



12 FIRECLAY
APRON-FRONT
KITCHEN SINKS



28 FIRECLAY
DUAL-MOUNT KITCHEN SINKS



42 GRANITE
APRON-FRONT KITCHEN SINKS



46 GRANITE
DUAL-MOUNT
KITCHEN SINKS



58 KITCHEN
FAUCETS



64 KITCHEN FAUCET ACCESSORIES



66 WORKSTATION & SINK ACCESSORIES



78 BATHROOM COLLECTIONS



120 BATHROOM COMFORT & CARE ACCESSORIES



124 DISPLAY UNITS & WARRANTY INFO



132 INDEX SEARCH



BOCCHI ECO

With over 70 years of experience, BOCCHI is a leading brand in the kitchen and bathroom products industry. Since our establishment in 1950, the values of BOCCHI have never changed: creative and innovative excellence at every level, as well as care for people and for the environment.

Our mission has always been to offer our partners innovative, high-quality and creative solutions in products and services to provide a unique and valued experience.

Today, BOCCHI harmoniously brings together tradition and design, and proudly stands for quality, durability and care.

Using sustainable processes and practices, we make it our priority to care for the environment through every step of production. Our products are built on tradition, designed for your busy life, and with the utmost care for tomorrow.

BOCCHI[®]
FOR EVERY SHADE OF YOU



EXCLUSIVE BOCCHI COLORS

Color choices in the home create focal points, convey emotions and reflect our personal style.

Now BOCCHI gives you the opportunity to carry all these colors into your kitchen. You can create unique color stories in your home that balance the natural focal point created by your kitchen sink with the harmony created by your other finishes.

What color will you choose?



BATHROOM COLORS



White
(001)



Matte White
(002)



Matte Black
Fireclay (004)



Black
Fireclay (005)



Matte Gray
Fireclay (006)



Sapphire Blue
Fireclay (010)



Orange
Fireclay (012)



Biscuit
Fireclay (014)



Matte Ice Blue
Fireclay (029)



Matte Mint Green
Fireclay (033)



Platinum
Fireclay (401)

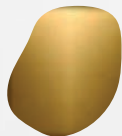

Matte Gold
Fireclay (403)

KITCHEN COLORS



White
Fireclay (001)



Matte White
Fireclay (002)



Matte Black
Fireclay (004)



Black
Fireclay (005)



Matte Gray
Fireclay (006)



Sapphire Blue
Fireclay (010)



Biscuit
Fireclay (014)



Matte Dark Gray
Fireclay (020)



Matte Brown
Fireclay (025)

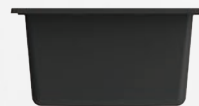

Matte Black
Granite (504)



Metallic Black
Granite (505)



Concrete Gray
Granite (506)

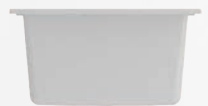

Milk White
Granite (507)



SUPER SMOOTH SURFACE

Super Smooth Surface technology has been developed to minimize lime remains, undesirable dirt and bacteria on ceramic surfaces and make cleaning easier. This technology is the result of many years of research.

Super Smooth Surface is 19 times smoother and has less roughness than regularly glazed surfaces.

Test results show that super smooth technology provides a surface that has a higher quality than regular porcelain surfaces. Therefore, the Super Smooth Surface requires much less water to clean and is more hygienic.

19X SMOOTHER, 19X EASIER



CLEAN+ TECHNOLOGY

Another innovative enhancement from BOCCHI is the Clean+ Technology. This technology helps you keep your kitchen sink always brilliant, clean, shiny and new.

Clean+ Technology decreases roughness so the contact angle of the ceramic surface can create a hydrophobic effect, which helps to prevent lime remains and undesirable dirt build up.

A smooth wipe and a mild cleaning would be sufficient to maintain the spark of your kitchen.

developed by
BOCCHI

FIRECLAY

APRON FRONT SINKS



BOCCHI Clean+
Easier to clean & stays clean longer



Food-Safe
Absolutely safe for food and safe for you



Heat Proof
Extreme heat from pots and pans or almost anything



Super Smooth Surface
19 Times smoother than ordinary fireclay surface



Stain Resistant
Food/drink stains cannot stick



UV-Protected
Won't fade or discolor



Anti-Splash
Protect your cabinets



Impact-Resistant
Extremely durable and scratch resistant



Sloping Drains
Easy flow of water for easy cleaning



Deep Basins
No more twisting and turning pans to fit



Sound Dampening
Reduces noise and echoing





ULTRA SLIM

ADERCI

Aderci combines the strength of metal with the warmth of fireclay by adding aluminum to the classic fireclay composition to create walls half the thickness of typical fireclay.

Organically made, Aderci uses a complex blend of natural materials to achieve its sophisticated ultra-slim look...



Included Accessories

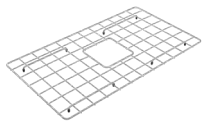

SS Sink Rack
2300 2015

● SS



SS Sink Strainer
2330 0001

● CH

Optional Accessories (Sold Separately)

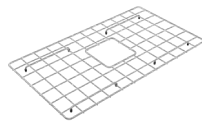

SS Sink Rack
2300 2015

● GM ● MB ● BG



SS Sink Strainer
2330 0001

● BG ● GM ● MW ● MB



Expandable Colander
2310 0006



Drain Cover
1220 XXX
(Available in 9 Colors)

- Sinks are reversible and fully glazed on all four sides



1481-XXX-0120
Apron-Front Single Bowl
30" x 18" x 10" 44 lbs
min. 33" wide base cabinet for apron sinks required

	1481-001-0120 white	\$1,201 USD
	1481-014-0120 biscuit	\$1,322 USD
	1481-002-0120 matte white	\$1,502 USD
	1481-004-0120 matte black	\$1,502 USD
	1481-005-0120 black	\$1,502 USD
	1481-006-0120 matte gray	\$1,502 USD
	1481-010-0120 sapphire blue	\$1,502 USD
	1481-020-0120 matte dark gray	\$1,502 USD
	1481-025-0120 matte brown	\$1,502 USD

CLASSIC FARMHOUSE

CLASSICO

Traditional farmhouse styling gives the large deep basins, and softly rounded edges that makes apron-fronts beloved...

The classics are classics for a reason.



Included Accessories



SS Sink Rack
2300 20XX

SS



SS Sink Strainer
2330 0001

CH

Optional Accessories (Sold Separately)

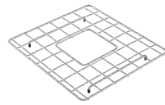

SS Sink Rack
2300 20XX

GM MB BG



SS Sink Strainer
2330 0001

BG GM MW MB



Expandable Colander
2310 0006



Drain Cover
1220 XXX
(Available in 9 Colors)

• Sinks are reversible and fully glazed on all four sides



1139-XXX-0120
Apron-Front Double Bowl
33" x 18" x 10" 92.46 lbs
min. 36" wide base cabinet for apron sinks required

	1139-001-0120 white	\$831 USD
	1139-014-0120 biscuit	\$914 USD
	1139-002-0120 matte white	\$1,038 USD
	1139-004-0120 matte black	\$1,038 USD
	1139-005-0120 black	\$1,038 USD
	1139-006-0120 matte gray	\$1,038 USD
	1139-010-0120 sapphire blue	\$1,038 USD
	1139-020-0120 matte dark gray	\$1,038 USD
	1139-025-0120 matte brown	\$1,038 USD



1138-XXX-0120
 Apron-Front Single Bowl
 30" x 18" x 10" 76.81 lbs
 min. 33" wide base cabinet for apron sinks required

- 1138-001-0120 white \$650 USD
- 1138-014-0120 biscuit \$715 USD
- 1138-002-0120 matte white \$813 USD
- 1138-004-0120 matte black \$813 USD
- 1138-005-0120 black \$813 USD
- 1138-006-0120 matte gray \$813 USD
- 1138-010-0120 sapphire blue \$813 USD
- 1138-020-0120 matte dark gray \$813 USD
- 1138-025-0120 matte brown \$813 USD



1137-XXX-0120
 Apron-Front Single Bowl
 24" x 18" x 10" 65.92 lbs
 min. 27" wide base cabinet for apron sinks required

- 1137-001-0120 white \$554 USD
- 1137-014-0120 biscuit \$609 USD
- 1137-002-0120 matte white \$692 USD
- 1137-004-0120 matte black \$692 USD
- 1137-005-0120 black \$692 USD
- 1137-006-0120 matte gray \$692 USD
- 1137-010-0120 sapphire blue \$692 USD
- 1137-020-0120 matte dark gray \$692 USD
- 1137-025-0120 matte brown \$692 USD



1136-XXX-0120
 Apron-Front Single Bowl
 20" x 18" x 10" 55.91 lbs
 min. 23" wide base cabinet for apron sinks required

- 1136-001-0120 white \$632 USD
- 1136-014-0120 biscuit \$695 USD
- 1136-002-0120 matte white \$790 USD
- 1136-004-0120 matte black \$790 USD
- 1136-005-0120 black \$790 USD
- 1136-006-0120 matte gray \$790 USD
- 1136-010-0120 sapphire blue \$790 USD
- 1136-020-0120 matte dark gray \$790 USD
- 1136-025-0120 matte brown \$790 USD

MODERN FARMHOUSE

CONTEMPO

Updated farmhouse sinks for today's kitchens. Featuring a straighter, sharper edge to the apron-front, these sinks are perfect for both traditional and contemporary spaces.



Included Accessories

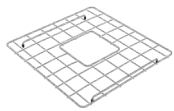

SS Sink Rack
2300 20XX

SS



SS Sink Strainer
2330 0001

CH

Optional Accessories (Sold Separately)

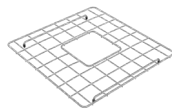

SS Sink Rack
2300 20XX

GM MB BG



SS Sink Strainer
2330 0001

BG GM MW MB



Drain Cover
1220 XXX
(Available in 9 Colors)

• Sinks are reversible and fully glazed on all four sides



1350-XXX-0120
Apron-Front Double Bowl
36" x 19" x 10" 104.06 lbs
min. 39" wide base cabinet for apron sinks required

	1350-001-0120 white	\$1,322 USD
	1350-014-0120 biscuit	\$1,454 USD
	1350-002-0120 matte white	\$1,652 USD
	1350-004-0120 matte black	\$1,652 USD
	1350-005-0120 black	\$1,652 USD
	1350-006-0120 matte gray	\$1,652 USD
	1350-010-0120 sapphire blue	\$1,652 USD
	1350-020-0120 matte dark gray	\$1,652 USD
	1350-025-0120 matte brown	\$1,652 USD

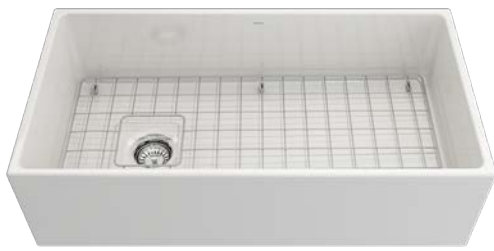

1354-XXX-0120
Apron-Front Single Bowl
36" x 19" x 10" 99.65 lbs
min. 39" wide base cabinet for apron sinks required

-  1354-001-0120 white \$1,201 USD
-  1354-014-0120 biscuit \$1,322 USD
-  1354-002-0120 matte white \$1,502 USD
-  1354-004-0120 matte black \$1,502 USD
-  1354-005-0120 black \$1,502 USD
-  1354-006-0120 matte gray \$1,502 USD
-  1354-010-0120 sapphire blue \$1,502 USD
-  1354-020-0120 matte dark gray \$1,502 USD
-  1354-025-0120 matte brown \$1,502 USD



1352-XXX-0120
Apron-Front Single Bowl
33" x 19" x 10" 99.10 lbs
min. 36" wide base cabinet for apron sinks required

-  1352-001-0120 white \$781 USD
-  1352-014-0120 biscuit \$859 USD
-  1352-002-0120 matte white \$976 USD
-  1352-004-0120 matte black \$976 USD
-  1352-005-0120 black \$976 USD
-  1352-006-0120 matte gray \$976 USD
-  1352-010-0120 sapphire blue \$976 USD
-  1352-020-0120 matte dark gray \$976 USD
-  1352-025-0120 matte brown \$976 USD



1346-XXX-0120
Apron-Front Single Bowl
30" x 19" x 10" 96.69 lbs
min. 33" wide base cabinet for apron sinks required

-  1346-001-0120 white \$650 USD
-  1346-014-0120 biscuit \$715 USD
-  1346-002-0120 matte white \$813 USD
-  1346-004-0120 matte black \$813 USD
-  1346-005-0120 black \$813 USD
-  1346-006-0120 matte gray \$813 USD
-  1346-010-0120 sapphire blue \$813 USD
-  1346-020-0120 matte dark gray \$813 USD
-  1346-025-0120 matte brown \$813 USD



1356-XXX-0120
Apron-Front Single Bowl
27" x 19" x 10" 77.74 lbs
min. 30" wide base cabinet for apron sinks required

-  1356-001-0120 white \$710 USD
-  1356-014-0120 biscuit \$781 USD
-  1356-002-0120 matte white \$888 USD
-  1356-004-0120 matte black \$888 USD
-  1356-005-0120 black \$888 USD
-  1356-006-0120 matte gray \$888 USD
-  1356-010-0120 sapphire blue \$888 USD
-  1356-020-0120 matte dark gray \$888 USD
-  1356-025-0120 matte brown \$888 USD

INTEGRATED WORKSTATION

CONTEMPO STEP-RIM

Integrated workstation sinks that simplify your life and bring added function to the classic elegance of an apron-front sink.



• Sinks are reversible and fully glazed on all four sides; 1505 and 1344 feature an asymmetrical drain that may be left or right set as preferred.

Included Accessories

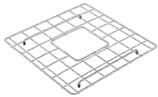

SS Sink Rack
2300 20XX
● SS



Wooden Cutting Board
2320 0001



Colander w/
Wooden Handles
2310 0003



SS Sink Strainer
2330 0001
● CH

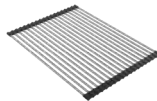

Roller Mat
2350 0001



SS Sink Strainer
2330 0001
● BG ● GM ● MW ● MB

Optional Accessories (Sold Separately)

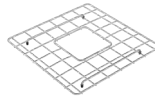

SS Sink Rack
2300 20XX
● GM ● MB ● BG

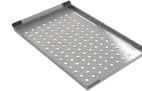

Colander Tray
2310 0005



Expandable
Colander
2310 0006



Prep Board w/
Knife Slots And
Colanders
2320 0009



Drain Cover
1220 XXX
(Available in 9 Colors)



Prep Board w/ 3
Round Bowls
2320 0011



Prep Board w/3
Rectangular Bowls
2320 0013



Prep Board
Includes Large
Mixing Bowl and
Large Colander
2320 0015



1348-XXX-0120
Apron-Front Double Bowl
36" x 19" x 10" 118.34 lbs
min. 39" wide base cabinet for apron sinks required
Includes cutting board, colander, roller mat, grid & strainer

	1348-001-0120 white	\$1,442 USD
	1348-014-0120 biscuit	\$1,587 USD
	1348-002-0120 matte white	\$1,803 USD
	1348-004-0120 matte black	\$1,803 USD
	1348-005-0120 black	\$1,803 USD
	1348-006-0120 matte gray	\$1,803 USD
	1348-010-0120 sapphire blue	\$1,803 USD
	1348-020-0120 matte dark gray	\$1,803 USD
	1348-025-0120 matte brown	\$1,803 USD



1505-XXX-0120
Apron-Front Single Bowl
 36" x 19" x 10" 115.34 lbs
 min. 39" wide base cabinet for apron sinks required
 Includes cutting board, colander, roller mat, grid & strainer

- 1505-001-0120 white \$1,201 USD
- 1505-014-0120 biscuit \$1,322 USD
- 1505-002-0120 matte white \$1,502 USD
- 1505-004-0120 matte black \$1,502 USD
- 1505-005-0120 black \$1,502 USD
- 1505-006-0120 matte gray \$1,502 USD
- 1505-010-0120 sapphire blue \$1,502 USD
- 1505-020-0120 matte dark gray \$1,502 USD
- 1505-025-0120 matte brown \$1,502 USD



1504-XXX-0120
Apron-Front Single Bowl
 33" x 19" x 10" 112.34 lbs
 min. 36" wide base cabinet for apron sinks required
 Includes cutting board, colander, roller mat, grid & strainer

- 1504-001-0120 white \$1,082 USD
- 1504-014-0120 biscuit \$1,190 USD
- 1504-002-0120 matte white \$1,352 USD
- 1504-004-0120 matte black \$1,352 USD
- 1504-005-0120 black \$1,352 USD
- 1504-006-0120 matte gray \$1,352 USD
- 1504-010-0120 sapphire blue \$1,352 USD
- 1504-020-0120 matte dark gray \$1,352 USD
- 1504-025-0120 matte brown \$1,352 USD



1344-XXX-0120
Apron-Front Single Bowl
 30" x 19" x 10" 109.97 lbs
 min. 33" wide base cabinet for apron sinks required
 Includes cutting board, colander, roller mat, grid & strainer

- 1344-001-0120 white \$961 USD
- 1344-014-0120 biscuit \$1,058 USD
- 1344-002-0120 matte white \$1,202 USD
- 1344-004-0120 matte black \$1,202 USD
- 1344-005-0120 black \$1,202 USD
- 1344-006-0120 matte gray \$1,202 USD
- 1344-010-0120 sapphire blue \$1,202 USD
- 1344-020-0120 matte dark gray \$1,202 USD
- 1344-025-0120 matte brown \$1,202 USD



1628-XXX-0120
Apron-Front Single Bowl
 27" x 19" x 10" 71.00 lbs
 min. 30" wide base cabinet for apron sinks required
 Includes cutting board, colander, roller mat and strainer

- 1628-001-0120 white \$850 USD
- 1628-014-0120 biscuit \$935 USD
- 1628-002-0120 matte white \$1,063 USD
- 1628-004-0120 matte black \$1,063 USD
- 1628-005-0120 black \$1,063 USD
- 1628-006-0120 matte gray \$1,063 USD
- 1628-010-0120 sapphire blue \$1,063 USD
- 1628-020-0120 matte dark gray \$1,063 USD
- 1628-025-0120 matte brown \$1,063 USD

RETROFITS MADE EASY WITH SMART-FIT[®]

NUOVA

Retrofits are made easy with these unique apron-fronts. A shorter 8 inch face allows them to be used with standard base cabinets before dropping back to a deeper 10 inches. Drop-in installation recommended to accommodate the faucet deck.



Included Accessories

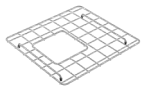

SS Sink Rack
2300 20XX
● SS



SS Sink Strainer
2330 0001
● CH

Optional Accessories (Sold Separately)

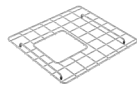

SS Sink Rack
2300 20XX
● GM ● MB ● BG



SS Sink Strainer
2330 0001
● BG ● GM ● MW ● MB



Wooden Cutting Board
2320 0004

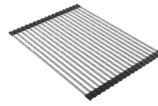

Roller Mat
2350 0005



Colander w/
Wooden Handles
2310 0008



Drain Cover
1220 XXX
(Available in 9 Colors)

• Nuova sinks are pre-drilled for a 3-hole faucet setting; single hole faucets will require a deck plate.



*drop-in recommended
*for easy retrofit

1500-XXX-0127
Apron-Front Single Bowl
34" x 24" x 10" (face= 8") 76.89 lbs
min. 36" wide base cabinet required
fits standard style base cabinets/apron-front style not required

■ 1500-001-0127 white	\$741 USD
■ 1500-014-0127 biscuit	\$815 USD
■ 1500-002-0127 matte white	\$926 USD
■ 1500-004-0127 matte black	\$926 USD
■ 1500-005-0127 black	\$926 USD
■ 1500-006-0127 matte gray	\$926 USD
■ 1500-010-0127 sapphire blue	\$926 USD
■ 1500-020-0127 matte dark gray	\$926 USD
■ 1500-025-0127 matte brown	\$926 USD



*drop-in recommended
*for easy retrofit

1501-XXX-0127

Apron-Front Double Bowl

34" x 24" x 10" (face= 8") 85.87 lbs

min. 36" wide base cabinet required

fits standard style base cabinets/apron-front style not required

	1501-001-0127 white	\$926 USD
	1501-014-0127 biscuit	\$1,019 USD
	1501-002-0127 matte white	\$1,158 USD
	1501-004-0127 matte black	\$1,158 USD
	1501-005-0127 black	\$1,158 USD
	1501-006-0127 matte gray	\$1,158 USD
	1501-010-0127 sapphire blue	\$1,158 USD
	1501-020-0127 matte dark gray	\$1,158 USD
	1501-025-0127 matte brown	\$1,158 USD



RETROFITS MADE EASY WITH SMART-FIT®

NUOVA PRO

Featuring short-faces and SMART-FIT technology, Nuova Pros fit on standard base cabinets and hide marks from rough cuts. Choose an undermount, semi-reveal undermount (for use with accessories), or a drop-in installation.



Included Accessories

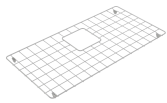

SS Sink Rack
2300 20XX
● SS



SS Sink Strainer
2330 0001
● CH

Optional Accessories (Sold Separately)

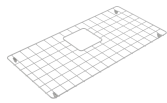

SS Sink Rack
2300 20XX
● GM ● MB ● BG



SS Sink Strainer
2330 0001
● BG ● GM ● MW ● MB



Wooden Cutting Board
2320 0004

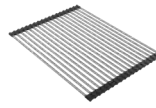

Roller Mat
2350 0005



Colander w/
Wooden Handles
2310 0008



Drain Cover
1220 XXX
(Available in 9 Colors)

• Nuova Pro sinks allow for undermount or drop-in installation; use semi-reveal ledge for undermount installations when using accessories.



*choose undermount or drop-in
*for easy retrofit

1551-XXX-0120
Apron-Front Single Bowl
34" x 24" x 10" (face=6.65") 68.86 lbs
min. 36" wide base cabinet required
fits standard style base cabinets/apron-front style not required

	1551-001-0120 white	\$721 USD
	1551-014-0120 biscuit	\$794 USD
	1551-002-0120 matte white	\$902 USD
	1551-004-0120 matte black	\$902 USD
	1551-005-0120 black	\$902 USD
	1551-006-0120 matte gray	\$902 USD
	1551-010-0120 sapphire blue	\$902 USD
	1551-020-0120 matte dark gray	\$902 USD
	1551-025-0120 matte brown	\$902 USD

BOCCHI Co. reserves the right to make changes to colors/finishes, dimensions and prices of the products at any time. Colors/finishes may look different in real life. Product must be seen for actual color/finish example.



ITALIAN FARMHOUSE

VIGNETO

Influenced by the Italian countryside, this sophisticated apron-front features a decorative grapevine pattern for a touch of elegant style.



Included Accessories

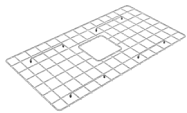

SS Sink Rack
2300 2004

● SS



SS Sink Strainer
2330 0001

● CH

Optional Accessories (Sold Separately)

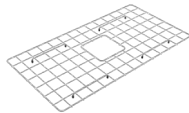

SS Sink Rack
2300 2004

● GM ● MB ● BG



SS Sink Strainer
2330 0001

● BG ● GM ● MW ● MB



Drain Cover
1220 XXX
(Available in 9 Colors)

• Sinks are fully glazed on all four sides but grapevine detail is on front side only



1353-XXX-0120
Apron-Front Single Bowl
33" x 19" x 10" 99.10 lbs
min. 36" wide base cabinet for apron sinks required

	1353-001-0120 white	\$1,142 USD
	1353-014-0120 biscuit	\$1,256 USD
	1353-002-0120 matte white	\$1,427 USD
	1353-004-0120 matte black	\$1,427 USD
	1353-005-0120 black	\$1,427 USD
	1353-006-0120 matte gray	\$1,427 USD
	1353-010-0120 sapphire blue	\$1,427 USD
	1353-020-0120 matte dark gray	\$1,427 USD
	1353-025-0120 matte brown	\$1,427 USD



FIRECLAY

DUAL-MOUNT KITCHEN & BAR SINKS



BOCCHI Clean+
Easier to clean &
stays clean longer



Food-Safe
Absolutely safe for
food and safe for you



Heat Proof
Extreme heat from
pots and pans or
almost anything



Super Smooth Surface
19 Times smoother than
ordinary fireclay surface



Stain Resistant
Food/drink stains
cannot stick



UV-Protected
Won't fade or discolor



Anti-Splash
Protect your cabinets



Impact-Resistant
Extremely durable and
scratch resistant



Sloping Drains
Easy flow of water
for easy cleaning



Deep Basins
No more twisting and
turning pans to fit



Sound Dampening
Reduces noise
and echoing



UNDERMOUNT



DROP-IN



UNDERMOUNT WITH SEMI-REVEAL

WORKSTATION DUAL-MOUNT

SOTTO STEP-RIM

Deep basin workstation sinks with a built-in step-rim for easy undermount installation.

Fully glazed lip allows for drop-in option.



- Integrated workstation ledge for easy installation; fully glazed lip for drop-in option. Fully reversible so you choose your drain placement

Included Accessories

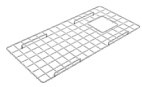

SS Sink Rack
2300 20XX

SS



Wooden Cutting Board
2320 0006



Colander w/
Wooden Handles
2310 0007



SS Sink Strainer
2330 0001

CH

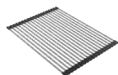

Roller Mat
2350 0004

Optional Accessories (Sold Separately)



Prep Board w/
Knife Slots
And Colanders
2320 0008



Expandable
Colander
2310 0006

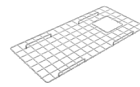

SS Sink Rack
2300 20XX

GM MB BG



Drain Cover
1220 XXX
(Available in 9 Colors)



Prep Board
w/ 3
Round Bowls
2320 0010



Prep Board
w/3
Rectangular
Bowls
2320 0012



Prep Board
Includes Large
Mixing Bowl
and Large
Colander
2320 0014



SS Sink Strainer
2330 0001

BG GB MW MB



1693-XXX-0120
Dual-Mount Single Bowl
34"x19"x10" 70 lbs
min. 36" wide base cabinet required

	1693-001-0120 white	\$825 USD
	1693-014-0120 biscuit	\$908 USD
	1693-002-0120 matte white	\$1,032 USD
	1693-004-0120 matte black	\$1,032 USD
	1693-005-0120 black	\$1,032 USD
	1693-006-0120 matte gray	\$1,032 USD
	1693-010-0120 sapphire blue	\$1,032 USD
	1693-020-0120 matte dark gray	\$1,032 USD
	1693-025-0120 matte brown	\$1,032 USD



1694-XXX-0120
 60/40 Dual-Mount Double Bowl
 34"x19"x10" 77 lbs
 min. 36" wide base cabinet required

- | | | |
|---|-------------------------------|-------------|
|  | 1694-001-0120 white | \$895 USD |
|  | 1694-014-0120 biscuit | \$985 USD |
|  | 1694-002-0120 matte white | \$1,119 USD |
|  | 1694-004-0120 matte black | \$1,119 USD |
|  | 1694-005-0120 black | \$1,119 USD |
|  | 1694-006-0120 matte gray | \$1,119 USD |
|  | 1694-010-0120 sapphire blue | \$1,119 USD |
|  | 1694-020-0120 matte dark gray | \$1,119 USD |
|  | 1694-025-0120 matte brown | \$1,119 USD |



SEMI-REVEAL UNDERMOUNT OR DROP-IN

SOTTO

You choose your installation with deep, fireclay kitchen sinks you can undermount, drop-in or install with semi-reveal ledge to create a true workstation sink.



• Fully glazed lip; Dual-mount sinks with workstation option

Included Accessories

Optional Accessories (Sold Separately) *Accessories only work with drop-in or semi-reveal installations

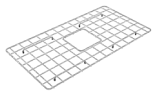

SS Sink Rack
2300 20XX

SS



SS Sink Strainer
2330 0001

CH

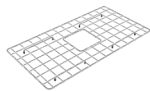

SS Sink Rack
2300 20XX

GM MB BG



SS Sink Strainer
2330 0001

BG GB MW MB



Prep Board w/
Knife Slots
And Colanders
2320 0009



Prep Board
w/ 3
Round Bowls
2320 0011

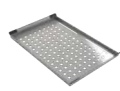

Colander Tray
2310 0005



Prep Board
w/3
Rectangular
Bowls
2320 0013



Expandable
Colander
2310 0006



Prep Board
Includes Large
Mixing Bowl
and Large
Colander
2320 0015



Wooden
Cutting Board
2320 0001



Colander w/
Wooden
Handles
2310 0003

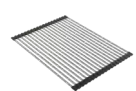

Colander Tray
2310 0001



Drain Cover
1220 XXX
(Available in 9 Colors)



1362-XXX-0120
Dual-Mount Single Bowl
32" x 19" x 10" 61.9 lbs
min. 35" wide base cabinet required

	1362-001-0120 white	\$716 USD
	1362-014-0120 biscuit	\$788 USD
	1362-002-0120 matte white	\$895 USD
	1362-004-0120 matte black	\$895 USD
	1362-005-0120 black	\$895 USD
	1362-006-0120 matte gray	\$895 USD
	1362-010-0120 sapphire blue	\$895 USD
	1362-020-0120 matte dark gray	\$895 USD
	1362-025-0120 matte brown	\$895 USD

BOCCHI Co. reserves the right to make changes to colors/finishes, dimensions and prices of the products at any time. Colors/finishes may look different in real life. Product must be seen for actual color/finish example.



1360-XXX-0120
Dual-Mount Single Bowl
26.75" x 19" x 10" 54.8 lbs
min. 30" wide base cabinet required

- 1360-001-0120 white \$705 USD
- 1360-014-0120 biscuit \$775 USD
- 1360-002-0120 matte white \$881 USD
- 1360-004-0120 matte black \$881 USD
- 1360-005-0120 black \$881 USD
- 1360-006-0120 matte gray \$881 USD
- 1360-010-0120 sapphire blue \$881 USD
- 1360-020-0120 matte dark gray \$881 USD
- 1360-025-0120 matte brown \$881 USD



1627-XXX-0120
Dual-Mount Single Bowl
24" x 19" x 10" 53.46 lbs
min. 27" wide base cabinet required

- 1627-001-0120 white \$522 USD
- 1627-014-0120 biscuit \$574 USD
- 1627-002-0120 matte white \$652 USD
- 1627-004-0120 matte black \$652 USD
- 1627-005-0120 black \$652 USD
- 1627-006-0120 matte gray \$652 USD
- 1627-010-0120 sapphire blue \$652 USD
- 1627-020-0120 matte dark gray \$652 USD
- 1627-025-0120 matte brown \$652 USD



SEMI-REVEAL UNDERMOUNT OR DROP-IN

SOTTO BAR SINKS

You choose your installation with deep, fireclay bar sinks you can undermount or drop-in. Added option for a semi-reveal, undermount installation on the square bar sink with a custom-fit cutting board cover.



Included Accessories

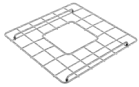

SS Sink Rack
2300 2009

SS



SS Sink Strainer
2330 0001

CH

Optional Accessories (Sold Separately)



SS Sink Rack
2300 2009

GM MB BG



Cutting Board
2320 0003



Expandable
Colander
2310 0006



SS Sink Strainer
2330 0001

BG GM MW MB



Drain Cover
1220 XXX
(Available in 9 Colors)



1359-XXX-0120

Dual-Mount Single Bowl
18" x 18" x 9" 32.67 lbs
min. 21" wide base cabinet required

	1359-001-0120 white	\$422 USD
	1359-014-0120 biscuit	\$464 USD
	1359-002-0120 matte white	\$527 USD
	1359-004-0120 matte black	\$527 USD
	1359-005-0120 black	\$527 USD
	1359-006-0120 matte gray	\$527 USD
	1359-010-0120 sapphire blue	\$527 USD
	1359-020-0120 matte dark gray	\$527 USD
	1359-025-0120 matte brown	\$527 USD

BOCCHI Co. reserves the right to make changes to colors/finishes, dimensions and prices of the products at any time. Colors/finishes may look different in real life. Product must be seen for actual color/finish example.



1358-XXX-0120
Dual-Mount Single Bowl
12" x 18" x 8" 22.88 lbs
min. 15" wide base cabinet
for apron sinks required

- 1358-001-0120 white \$332 USD
- 1358-014-0120 biscuit \$365 USD
- 1358-002-0120 matte white \$415 USD
- 1358-004-0120 matte black \$415 USD
- 1358-005-0120 black \$415 USD
- 1358-006-0120 matte gray \$415 USD
- 1358-010-0120 sapphire blue \$415 USD
- 1358-020-0120 matte dark gray \$415 USD
- 1358-025-0120 matte brown \$415 USD

Included Accessories

Optional Accessories (Sold Separately)



SS Sink Strainer
2330 0001
● CH



SS Sink Strainer
2330 0001
● BG ● GM ● MW ● MB



Drain Cover
1220 XXX
(Available in 9 Colors)



1361-XXX-0120
Dual-Mount Single Bowl
ø 18" x 10" 26.63 lbs
min. 21" wide base cabinet required

- 1361-001-0120 white \$541 USD
- 1361-014-0120 biscuit \$595 USD
- 1361-002-0120 matte white \$676 USD
- 1361-004-0120 matte black \$676 USD
- 1361-005-0120 black \$676 USD
- 1361-006-0120 matte gray \$676 USD
- 1361-010-0120 sapphire blue \$676 USD
- 1361-020-0120 matte dark gray \$676 USD
- 1361-025-0120 matte brown \$676 USD

Included Accessories

Optional Accessories (Sold Separately)

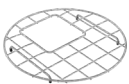

SS Sink Rack
2300 2011
● SS



SS Sink Strainer
2330 0001
● CH

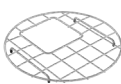

SS Sink Rack
2300 2011
● GM ● MB ● BG



SS Sink Strainer
2330 0001
● BG ● GM ● MW ● MB



Drain Cover
1220 XXX
(Available in 9 Colors)





HIDE-AWAY UNDERMOUNT OR DROP-IN

BAVENO

Unique dual-mount, workstation sinks that completely hide away to create more counter space when needed. May be dropped-in or undermounted to completely conceal sink when used with telescopic, hide-away faucets. Great for small kitchens, laundry rooms, and bar areas.



- Fully glazed lip. Undermount or drop-in installation; create a completely hidden look when used with telescopic 2-hole faucets (Baveno Move or Baveno Move+); 3-hole sink model designed for use with a soap dispenser and a 2-hole faucet

Included Accessories

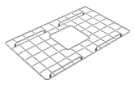

SS Sink Rack
2300 20XX
● SS



Wooden Cutting Board
(Inner Ledge)
2320 0006



Colander w/
Wooden Handles
(Inner Ledge)
2310 0007



Wooden Cutting Board/Covers
(Outer Ledge)
2320 00XX (x2)



SS Sink Strainer
2330 0001
● CH

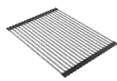

Roller Mat
(Inner Ledge)
2350 0004



Roller Mat
(Outer Ledge)
2350 0005



1633-XXX-0132
Dual-Mount, Hide-Away Single Bowl
2-hole faucet drilling
27" x 19" x 10" 49 lbs
min. 30" wide base cabinet required
2-hole setting for use with Baveno Move and Move+ faucets
Includes select Baveno accessories for inner and outer ledge

Optional Accessories (Sold Separately)

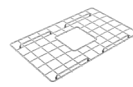

SS Sink Rack
2300 20XX
● GM ● MB ● BG



Colander Tray
2310 0005



Expandable
Colander
2310 0006



Prep Board w/
Knife Slots
And Colanders
2320 0009



Drain Cover
1220 XXX
(Available in 9 Colors)



SS Sink Strainer
2330 0001
● BG ● GB ● MW ● MB



Prep Board
w/3
Round Bowls
2320 0011



Prep Board
w/3
Rectangular
Bowls
2320 0013



Prep Board
Includes Large
Mixing Bowl
and Large
Colander
2320 0015

■ 1633-001-0132 white	\$819 USD
■ 1633-014-0132 biscuit	\$901 USD
■ 1633-002-0132 matte white	\$1,024 USD
■ 1633-004-0132 matte black	\$1,024 USD
■ 1633-005-0132 black	\$1,024 USD
■ 1633-006-0132 matte gray	\$1,024 USD
■ 1633-010-0132 sapphire blue	\$1,024 USD
■ 1633-020-0132 matte dark gray	\$1,024 USD
■ 1633-025-0132 matte brown	\$1,024 USD



1633-XXX-0127

Dual-Mount, Hide-Away Single Bowl

3-hole faucet drilling

27" x 19" x 10" 49 lbs

min. 30" wide base cabinet required

3rd left-set hole perfect for Baveno soap dispenser

Includes select Baveno accessories for inner and outer ledges

-  1633-001-0127 white \$819 USD
-  1633-014-0127 biscuit \$901 USD
-  1633-002-0127 matte white \$1,024 USD
-  1633-004-0127 matte black \$1,024 USD
-  1633-005-0127 black \$1,024 USD
-  1633-006-0127 matte gray \$1,024 USD
-  1633-010-0127 sapphire blue \$1,024 USD
-  1633-020-0127 matte dark gray \$1,024 USD
-  1633-025-0127 matte brown \$1,024 USD



1695-XXX-0132

Dual-Mount, Hide-Away Single Bowl

2-hole faucet drilling

34" x 19" x 10" 60 lbs

min. 36" wide base cabinet required

2-hole settings for use w/ Baveno Move and Move+ faucets

Includes select Baveno accessories for inner and outer ledge

-  1695-001-0132 white \$979 USD
-  1695-014-0132 biscuit \$1,077 USD
-  1695-002-0132 matte white \$1,224 USD
-  1695-004-0132 matte black \$1,224 USD
-  1695-005-0132 black \$1,224 USD
-  1695-006-0132 matte gray \$1,224 USD
-  1695-010-0132 sapphire blue \$1,224 USD
-  1695-020-0132 matte dark gray \$1,224 USD
-  1695-025-0132 matte brown \$1,224 USD



1695-XXX-0127

Dual-Mount, Hide-Away Single Bowl

3-hole faucet drilling

34" x 19" x 10" 60 lbs

min. 36" wide base cabinet required

3rd left-set hole perfect for Baveno soap dispenser

Includes select Baveno accessories for inner and outer ledge

-  1695-001-0127 white \$979 USD
-  1695-014-0127 biscuit \$1,077 USD
-  1695-002-0127 matte white \$1,224 USD
-  1695-004-0127 matte black \$1,224 USD
-  1695-005-0127 black \$1,224 USD
-  1695-006-0127 matte gray \$1,224 USD
-  1695-010-0127 sapphire blue \$1,224 USD
-  1695-020-0127 matte dark gray \$1,224 USD
-  1695-025-0127 matte brown \$1,224 USD





GRANITE

APRON FRONT SINKS



BOCCHI Clean+
Easier to clean &
stays clean longer



Food-Safe
Absolutely safe for
food and safe for you



Heat Proof
Extreme heat from
pots and pans or
almost anything



Stain Resistant
Food/drink stains
cannot stick



UV-Protected
Won't fade or discolor



Sound Dampening
Reduces noise
and echoing



Deep Basins
No more twisting and
turning pans to fit



Impact-Resistant
Extremely durable and
scratch resistant

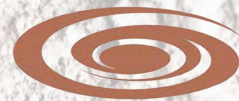

Sloping Drains
Easy flow of water
for easy cleaning



BOCCHI

Arona - Reversible

Apron - Front Kitchen Sink



INSTALLATION OPTION A = STRAIGHTER, MORE MODERN LINES



INSTALLATION OPTION B = ROUNDER, MORE CLASSIC LINES

REVERSIBLE

ARONA STEP-RIM

Dual faced, apron-front workstation sinks that simplify your life and bring function and elegance to a new level; select accessories included.

Choose from a modern or a traditional front.



• Sinks are reversible, choose your preferred face style

Included Accessories



Wooden Cutting Board
2320 0005



Colander w/
Silicone Handles
2310 0004



Sink Strainer
2330 0005

CH

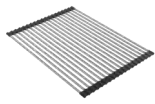

Roller Mat
2350 0003

Optional Accessories (Sold Separately)

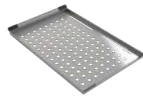

Colander Tray
2310 0005



Expandable Colander
2310 0006



Sink Strainer
2330 0001

BG GM MW MB



1600-XXX-0120

Apron-Front Single Bowl

33" x 20.5" x 9.5" 53 lbs

min. 36" wide base cabinet for apron sinks required

- 1600-504-0120 matte black \$1,219 USD
- 1600-505-0120 metallic black \$1,219 USD
- 1600-506-0120 concrete gray \$1,219 USD

GRANITE

DUAL-MOUNT SINKS



BOCCHI Clean+
Easier to clean &
stays clean longer



Food-Safe
Absolutely safe for
food and safe for you



Heat Proof
Extreme heat from
pots and pans or
almost anything



Stain Resistant
Food/drink stains
cannot stick



UV-Protected
Won't fade or discolor



Sound Dampening
Reduces noise
and echoing



Deep Basins
No more twisting and
turning pans to fit



Impact-Resistant
Extremely durable and
scratch resistant



Sloping Drains
Easy flow of water
for easy cleaning



UNDERMOUNT OR DROP-IN

CAMPINO

Classic granite sinks you can undermount or drop-in to add style and function to your kitchen or bar area.



- Pre-drilled for a single-hole faucet with options to punch-out additional holes as needed

Included Accessories

Optional Accessories (Sold Separately)



Sink Strainer
2330 0005
CH



Sink Strainer
2330 0001
BG GM MW MB



Expandable
Colander
2310 0006
Fits: 1602, 1604,
1606, 1608, 1634



Cutting Board
2320 0005
Fits: 1606, 1634
2320 0004
Fits: 1604

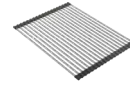

Roller Mat
2350 0003
Fits: 1606, 1608,
1634
2350 0005
Fits: 1602, 1604



Colander
2310 0008
Fits: 1604
2310 0003
Fits: 1606



Colander
2310 0004
Fits: 1634



1602-XXX-0126

Dual-Mount Double Bowl
33" x 22" x 9.5" 44 lbs

min. 36" wide base cabinet required; pre-drilled for a single-hole faucet, prescored for easy punch out of additional holes as needed

- 1602-504-0126 matte black \$551 USD
- 1602-505-0126 metallic black \$551 USD
- 1602-506-0126 concrete gray \$551 USD
- 1602-507-0126 milk white \$551 USD



1604-XXX-0126

Dual-Mount Single Bowl
33" x 22" x 9.5" 45 lbs

min. 36" wide base cabinet required; pre-drilled for a single-hole faucet, prescored for easy punch out of additional holes as needed

- 1604-504-0126 matte black \$505 USD
- 1604-505-0126 metallic black \$505 USD
- 1604-506-0126 concrete gray \$505 USD
- 1604-507-0126 milk white \$505 USD



1634-XXX-0126

Dual-Mount Single Bowl
27" x 20" x 8" 32 lbs

min. 30" wide base cabinet required; pre-drilled for a single-hole faucet, prescored for easy punch out of additional holes as needed

- 1634-504-0126 matte black \$460 USD
- 1634-505-0126 metallic black \$460 USD
- 1634-506-0126 concrete gray \$460 USD
- 1634-507-0126 milk white \$460 USD



1606-XXX-0126

Dual-Mount Single Bowl
24" x 20" x 8" 29 lbs

min. 27" wide base cabinet required; pre-drilled for a single-hole faucet, prescored for easy punch out of additional holes as needed

- 1606-504-0126 matte black \$403 USD
- 1606-505-0126 metallic black \$403 USD
- 1606-506-0126 concrete gray \$403 USD
- 1606-507-0126 milk white \$403 USD



1608-XXX-0126

Dual-Mount Single Bowl
16" x 20" x 8" 22 lbs

min. 19" wide base cabinet required; pre-drilled for a single-hole faucet, prescored for easy punch out of additional holes as needed

- 1608-504-0126 matte black \$392 USD
- 1608-505-0126 metallic black \$392 USD
- 1608-506-0126 concrete gray \$392 USD
- 1608-507-0126 milk white \$392 USD



UNDERMOUNT



DROP-IN



UNDERMOUNT



DROP-IN

HIDE-AWAY UNDERMOUNT

BAVENO LUX

Unique undermount, workstation sink that completely hides away to create more counter space when needed.

Great for small kitchens, laundry rooms, and bar areas.



- Sinks are predrilled for a single hole faucet with options for easy punch out of additional holes. 1616 Models may be installed as a drop-in or undermount; if installed as a drop-in covers will sit above the counter height / 1618 models are undermount only (leveling bands on 1618 sides are completely hidden after installation)

Included Accessories



Wooden Cutting Board
2320 0006



Colander w/
Wooden Handles
2310 0007



HPL Cutting Board
/ Covers
2320 0016 (x2)
(included with
161X-XXX-0126HP
models only;
otherwise sold
separately)



Sink Strainer
2330 0005

CH

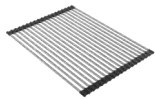

Roller Mat
2350 0004

Optional Accessories (Sold Separately)



Prep Board w/
Knife Slots And
Colanders
2320 0008



Prep Board w/3
Rectangular Bowls
2320 0012



Prep Board Includes
Large Mixing Bowl and
Large Colander
2320 0014



Prep Board w/3
Round Bowls
2320 0010



Sink Strainer
2330 0001

BG GM MW MB



HPL Cutting Board
/ Covers
2320 0016 (x2)
(included with
161X-XXX-0126HP
models only;
otherwise sold
separately)



Expandable Colander
2310 0006



1616-XXX-0126
Dual-Mount, Single Bowl
33.75" x 20" x 9.5" 39 lbs
min. 36" wide base cabinet required

- 1616-504-0126 matte black \$902 USD
- 1616-505-0126 metallic black \$902 USD
- 1616-506-0126 concrete gray \$902 USD
- 1616-507-0126 milk white \$902 USD



1616-XXX-0126HP
Dual-Mount, Single Bowl WITH COVERS
33.75" x 20" x 9.5" 48 lbs
min. 36" wide base cabinet required

- 1616-504-0126HP matte black \$1,242 USD
- 1616-505-0126HP metallic black \$1,242 USD
- 1616-506-0126HP concrete gray \$1,242 USD
- 1616-507-0126HP milk white \$1,242 USD





1618-XXX-0126
 Undermount, Double Bowl
 33.75" x 20" x 9.5" 39 lbs
 min. 36" wide base cabinet required

- 1618-504-0126 matte black \$902 USD
- 1618-505-0126 metallic black \$902 USD
- 1618-506-0126 concrete gray \$902 USD
- 1618-507-0126 milk white \$902 USD



1618-XXX-0126HP
 Undermount, Double Bowl WITH COVERS
 33.75" x 20" x 9.5" 48 lbs
 min. 36" wide base cabinet required

- 1618-504-0126HP matte black \$1,242 USD
- 1618-505-0126HP metallic black \$1,242 USD
- 1618-506-0126HP concrete gray \$1,242 USD
- 1618-507-0126HP milk white \$1,242 USD







KITCHEN COLLECTION

INTEGRATED DRAIN BOARD

LEVANZO

Dual-mount sinks with extended and reversible drain boards designed to keep wet areas contained and counters clean and dry.

Maximizes workspace and elegantly keeps wet areas contained.



- Undrilled to allow for reversible installation with easy punch-out for single-hole faucet setting on either side to allow for drain board to be placed on left or right. May be installed as a drop-in or undermount with integrated drain board set to the desired side. Drain board may be extended over side cabinets to allow for more flexible installations. Fits on cabinets as small as 24 inches wide.

Included Accessories

Optional Accessories (Sold Separately)



Sink Strainer
2330 0005

CH



Expandable
Colander
2310 0006

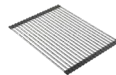

Roller Mat
2350 0003



Sink Strainer
2330 0001

BG GM MW MB



1635-XXX-0120
Dual-Mount Single Bowl w/ Drain Board
39" x 20" x 8" 42 lbs
min. 24" wide base cabinet required + extra space to
one side to accommodate the drain board, reversible

Side View:



- 1635-504-0120 matte black \$613 USD
- 1635-505-0120 metallic black \$613 USD
- 1635-506-0120 concrete gray \$613 USD



KITCHEN FAUCETS





- 1.75 gpm flow rate
- Brass body
- 35mm Ceramic Cartridge
- Standard or Needle Spray (Baveno Move and Move+ have standard only)
- 90° forward handle (Baveno Move and Move+ feature side control)
- Weighted, nylon braided pulldown and goose neck hoses
- 3.5" extended shank for easier installation on thick counters
- Extra-long (24") supply hoses
- Comes with stabilizer flange to make installation easier on thinner counters



2023 0001 XX
 Belsena 2.0 Faucet
 15.75" tall x 4.5" wide
 5 lbs

- 2023 0001 CH - chrome \$308 USD
- 2023 0001 SS - stainless steel \$352 USD
- 2023 0001 MB - matte black \$352 USD
- 2023 0001 BG - brushed gold \$352 USD



2024 0001 XX
 Pagano 2.0 Faucet
 15" tall x 4.5" wide
 4.5 lbs

- 2024 0001 CH - chrome \$264 USD
- 2024 0001 SS - stainless steel \$292 USD
- 2024 0001 MB - matte black \$292 USD
- 2024 0001 BG - brushed gold \$292 USD

BOCCHI Co. reserves the right to make changes to colors/finishes, dimensions and prices of the products at any time. Colors/finishes may look different in real life. Product must be seen for actual color/finish example.



2019 0001 XX
Maggiore 2.0 Faucet
26" tall x 4.5" wide
5 lbs

- 2019 0001 CH - chrome \$440 USD
- 2019 0001 SS - stainless steel \$495 USD
- 2019 0001 MB - matte black \$495 USD



2020 0001 XX
Livenza 2.0 Faucet
24" tall x 4.5" wide
4 lbs

- 2020 0001 CH - chrome \$330 USD
- 2020 0001 SS - stainless steel \$374 USD
- 2020 0001 MB - matte black \$374 USD



2025 0001 XX
Lugano 2.0 Faucet
18.5" tall x 4.5" wide
5 lbs

- 2025 0001 CH - chrome \$308 USD
- 2025 0001 SS - stainless steel \$352 USD
- 2025 0001 MB - matte black \$352 USD
- 2025 0001 BG - brushed gold \$352 USD



2026 0001 XX
Tronto 2.0 Faucet
16.5" tall x 4.25" wide
4.5 lbs

- 2026 0001 CH - chrome \$308 USD
- 2026 0001 SS - stainless steel \$352 USD
- 2026 0001 MB - matte black \$352 USD
- 2026 0001 BG - brushed gold \$352 USD



- 1.75 gpm flow rate
- Brass body
- 28 or 35 mm Ceramic Cartridges
- Standard or Needle Spray (Baveno Move and Move+ have standard only)
- 90° forward handle (Baveno Move and Move+ feature side control)
- Weighted, nylon braided pulldown and goose neck hoses
- Extra-long (24") supply hoses
- 3.5" extended shank for easier installation on thick counters
- Comes with stabilizer flange to make installation easier on thinner counters



2027 0001 XX
Baveno Pro Faucet
23.5" tall x 9" wide
6 lbs

- 2027 0001 CH - chrome \$765 USD
- 2027 0001 SS - stainless steel \$798 USD
- 2027 0001 GM - gun metal \$875 USD
- 2027 0001 BG - brushed gold \$875 USD



2028 0001 XX
Baveno Duo Faucet
16.5" tall x 8.75" wide
4 lbs

- 2028 0001 CH - chrome \$435 USD
- 2028 0001 SS - stainless steel \$501 USD
- 2028 0001 MB - matte black \$501 USD
- 2028 0001 MW - matte white \$501 USD
- 2028 0001 GM - gun metal \$545 USD
- 2028 0001 BG - brushed gold \$545 USD







BAVENO MOVE & BAVENO MOVE+ FEATURE TELESCOPIC MOVEMENT TO EASILY STORE BENEATH ACCESSORIES ON BAVENO SINKS AND COMPLETELY HIDE AWAY



2029 0001 XX
Baveno Move Faucet
8" tall x 9.5" wide
4 lbs





-  2029 0001 CH - chrome \$435 USD
-  2029 0001 SS - stainless steel \$501 USD
-  2029 0001 GM - gun metal \$545 USD
-  2029 0001 BG - brushed gold \$545 USD



2030 0001 XX
Baveno Move+ Faucet
8.25" tall x 8.85" wide
4 lbs



-  2030 0001 CH - chrome \$490 USD
-  2030 0001 SS - stainless steel \$545 USD
-  2030 0001 JB - jet black \$600 USD

BOCCHI Co. reserves the right to make changes to colors/finishes, dimensions and prices of the products at any time. Colors/finishes may look different in real life. Product must be seen for actual color/finish example.





SOAP DISPENSERS







2340 0005 XX
Lesina 2.0 Soap Dispenser
Brass body w/ 12oz. reservoir
Pull-off top for easy refill



2340 0006 XX
Tronto 2.0 Soap Dispenser
Brass body w/ 12oz. reservoir
Pull-off top for easy refill

-  2340 0005 CH - chrome \$50 USD
-  2340 0005 SS - stainless steel \$55 USD
-  2340 0005 MB - matte black \$55 USD
-  2340 0005 BG - brushed gold \$55 USD

-  2340 0006 CH - chrome \$50 USD
-  2340 0006 SS - stainless steel \$55 USD
-  2340 0006 MB - matte black \$55 USD
-  2340 0006 BG - brushed gold \$55 USD





DECK PLATES







2180 0003 XX
Contemporary Deck Plate
ABS body
Rust and corrosion resistant



2180 0004 XX
Traditional Deck Plate
Stainless Steel body
Rust and corrosion resistant







-  2180 0003 CH - chrome \$28 USD
-  2180 0003 SS - stainless steel \$33 USD
-  2180 0003 MB - matte black \$33 USD
-  2180 0003 BG - brushed gold \$33 USD

-  2180 0004 CH - chrome \$28 USD
-  2180 0004 SS - stainless steel \$33 USD
-  2180 0004 MB - matte black \$33 USD
-  2180 0004 BG - brushed gold \$33 USD

DISPENSERS CONT. & SINK PARTS



2340 0007 XX
 Baveno Soap Dispenser
 Brass body w/ 10.75oz. reservoir
 Pull-off top for easy refill

-  2340 0007 CH - chrome \$182 USD
-  2340 0007 SS - stainless steel \$215 USD
-  2340 0007 MB - matte black \$204 USD
-  2340 0007 MW - matte white \$204 USD
-  2340 0007 GM - gun metal \$215 USD
-  2340 0007 BG - brushed gold \$215 USD

NOTES: MB Matte Black finish will also match the JB Jet Black finish on the Baveno Move+ faucets

Will fit under the sink covers on the Baveno 1633-XXX-0127 and 1695-XXX-0127 sinks when used with Baveno Move or Baveno Move+ faucets

Strainers

Standard USA 3.5 in. Diameter

-  **2330 0001MW matte white** \$53 USD
(Fits to fireclay and granite sinks)
-  **2330 0001MB matte black** \$53 USD
(Fits to fireclay and granite sinks)
-  **2330 0001GM gun metal** \$53 USD
(Fits to fireclay and granite sinks)
-  **2330 0001CH chrome** \$53 USD
(Fits to fireclay and granite sinks)
2330 0005CH chrome
 (Fits only to granite sinks)
-  **2330 0001BG brushed gold** \$53 USD
(Fits to fireclay and granite sinks)









2360 0XXX
 Porcelain Touch-Up Glaze
 Color-matched to fireclay sinks
 Repair kit to hide small damages

-  2360 0001 white \$42 USD
-  2360 0014 biscuit \$42 USD
-  2360 0002 matte white \$42 USD
-  2360 0004 matte black \$42 USD
-  2360 0005 black \$42 USD
-  2360 0006 matte gray \$42 USD
-  2360 0010 sapphire blue \$42 USD
-  2360 0020 matte dark gray \$42 USD
-  2360 0025 matte brown \$42 USD



1220 0XX Luxury Drain Cover
 Color-matched fireclay. Sits above strainer to allow for easy water flow while providing chic cover for use with fireclay sinks.

-  1220 001 white \$22 USD
-  1220 014 biscuit \$25 USD
-  1220 002 matte white \$28 USD
-  1220 004 matte black \$28 USD
-  1220 005 black \$28 USD
-  1220 006 matte gray \$28 USD
-  1220 010 sapphire blue \$28 USD
-  1220 020 matte dark gray \$28 USD
-  1220 025 matte brown \$28 USD



WORKSTATION SINK ACCESSORIES





BAVENO HIDE-AWAY FIRECLAY SINK



CONTEMPO STEP-RIM SINKS

KITCHEN COLLECTION

COLANDERS

- All accessories may be ordered individually
- NOTE: some sinks are sold with certain accessories already included, refer to sink details for complete list of what is included
- Sotto sinks (non-step-rim models) require either a drop-in OR an undermount installation with an 11/16" semi-reveal, to be compatible with their selected accessories
- Stainless Steel accessories and parts are dishwasher safe



2310 0003 17-1/8" x 8" x 3"
Colander (Mahogany/Stainless Steel)
Fits: 1344, 1348, 1360, 1362, 1504, 1505, 1606, 1627, 1628

\$105 USD

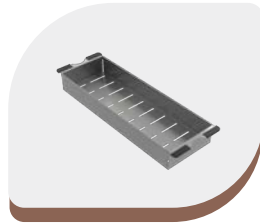

2310 0004 17" x 6" x 2-1/4"
Colander (Silicone/Stainless Steel)
Fits: 1600, 1606, 1608, 1634

\$94 USD

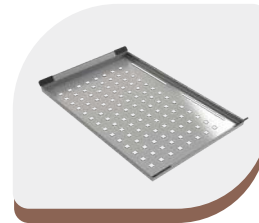

2310 0005 17-1/8" x 12" x 2"
Colander Tray (Stainless Steel)
Fits: 1344, 1348, 1360, 1362, 1504, 1505, 1606, 1627, 1628

\$83 USD

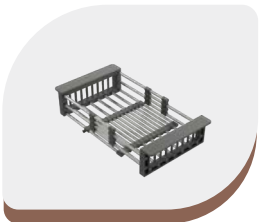

2310 0006 13" to 17" x 10" x 4"
Expandable Colander
(PP/Stainless Steel)
Fits: 1136, 1137, 1138, 1139, 1344, 1348, 1359, 1360, 1362, 1481, 1504, 1505, 1600, 1602, 1604, 1606, 1608, 1616, 1618, 1627, 1628, 1634, 1635, 1693, 1694, and inner ledge for 1633 & 1695

\$61 USD



2310 0007 16" x 8" x 3"
Colander (Mahogany/Stainless Steel)
Fits: 1616, 1618, 1693, 1694, and inner ledge for 1633 & 1695

\$94 USD



2310 0008 18-7/8" x 8" x 3"
Colander (Mahogany/Stainless Steel)
Fits: 1500, 1501, 1551 and 1604

\$112 USD

CUTTING & PREP BOARDS



2320 0001 17-1/8" x 11-7/8" x 7/8"
Cutting Board (Mahogany)
Fits: 1344, 1348, 1360, 1362, 1504, 1505,
1627, 1628
\$88 USD



2320 0003 16-1/8" x 16-1/8" x 7/8"
Cutting Board (Mahogany)
Fits: 1359
\$88 USD



2320 0004 18-1/2" x 11-1/2" x 7/8"
Cutting Board (Mahogany)
Fits: 1500, 1501, 1551 and 1604
\$99 USD



2320 0005 16-3/4" x 11-1/2" x 7/8"
Cutting Board (Mahogany)
Fits: 1600, 1606, 1634
\$105 USD



2320 0006 16" x 11-1/2" x 7/8"
Cutting Board (Mahogany)
Fits: 1616, 1618, 1693, 1694, and inner
ledge for 1633 & 1695
\$83 USD



2320 0007 20-1/2" x 12-3/4" x 7/8"
Cutting Board/Cover (Mahogany)
2 required to cover sink
Fits: 1633 (outer ledge)
\$105 USD / per board



2320 0008 16" x 7-7/8" x 7/8"
Prep Board (Mahogany/Stainless Steel)
w/ Knife Slots & 2 Colander Bowls
Fits: 1616, 1618, 1693, 1694, and inner
ledge for 1633 & 1695
\$99 USD



2320 0009 17-1/8" x 7-7/8" x 7/8"
Prep Board (Mahogany/Stainless Steel)
w/ Knife Slots & 2 Colander Bowls
Fits: 1344, 1348, 1360, 1362, 1504, 1505,
1627, 1628
\$105 USD



2320 0010 16" x 7-7/8" x 7/8"
Prep Board (Mahogany/Stainless Steel)
w/ 3 Solid, Round Prep Bowls
Fits: 1616, 1618, 1693, 1694, and inner
ledge for 1633 & 1695
\$110 USD



2320 0011 17-1/8" x 7-7/8" x 7/8"
Prep Board (Mahogany/Stainless Steel)
w/ 3 Solid, Round Prep Bowls
Fits: 1344, 1348, 1360, 1362, 1504,
1505, 1627, 1628
\$116 USD



2320 0012 16" x 8-2/3" x 7/8"
Prep Board (Mahogany/Stainless Steel)
w/ 3 Solid, Rectangular Prep Bowls
Fits: 1616, 1618, 1693, 1694, and inner
ledge for 1633 & 1695
\$110 USD



2320 0013 17-1/8" x 8-2/3" x 7/8"
Prep Board (Mahogany/Stainless Steel)
w/ 3 Solid, Rectangular Prep Bowls
Fits: 1344, 1348, 1360, 1362, 1504, 1505,
1627, 1628
\$116 USD

PREP BOARDS & ROLLER MATS

- All accessories may be ordered individually
- NOTE: some sinks are sold with certain accessories already included, refer to sink details for complete list of what is included
- Sotto sinks (non step-rim models) require either a drop-in OR an undermount installation with an 11/16 inch semi-reveal, to be compatible with their selected accessories
- Stainless Steel accessories and parts are dishwasher safe

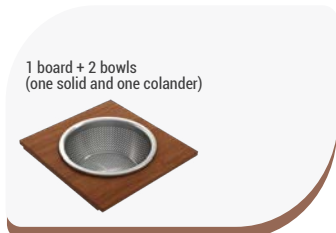

1 board + 2 bowls
(one solid and one colander)

2320 0014 16" x 15" x 7/8"
Prep Board (Mahogany/Stainless Steel)
w/ Large Solid (1) & Colander (1) Bowls Fits:
1616, 1618, 1693, 1694, and inner ledge for
1633 & 1695

\$138 USD

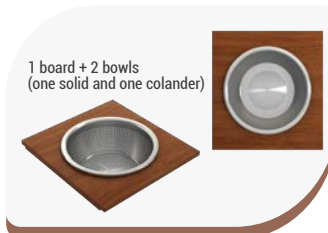

1 board + 2 bowls
(one solid and one colander)

2320 0015 17-1/8" x 15" x 7/8"
Prep Board (Mahogany/Stainless Steel)
w/ Large Solid (1) & Colander (1) Bowls
Fits: 1344, 1348, 1360, 1362, 1504, 1505,
1627, 1628

\$143 USD



2320 0016 16-1/8" x 15-1/2" x 3/8"
Cutting Board / Cover (HPL)
2 required to cover sink
Fits: 1616 and 1618

\$171 USD

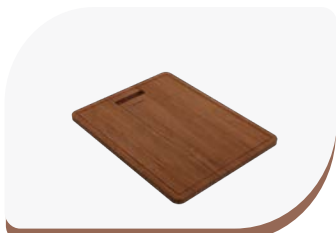

2320 0019 16-1/8" x 15-1/2" x 3/8"
Cutting Board / Cover (Mahogany)
required to cover sink
Fits: 1695 (outer ledge)

\$110 USD

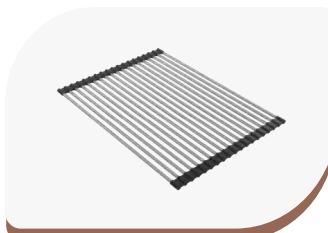

2350 0001 17-1/8" x 12-1/2" x 3/8"
Roller Mat (heat safe stainless steel)
Fits: 1344, 1348, 1360, 1362, 1504, 1505,
1627, 1628

\$72 USD

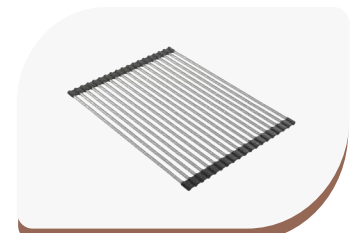

2350 0003 16-3/4" x 12-1/2" x 3/8"
Roller Mat (heat safe stainless steel)
Fits: 1600, 1606, 1608, 1634, and 1635

\$72 USD

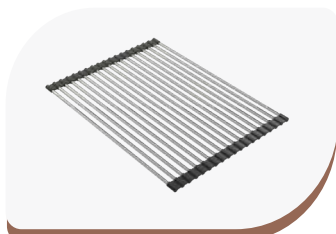

2350 0004 16" x 12-1/2" x 3/8"
Roller Mat (heat safe stainless steel)
Fits: 1616, 1618, 1693, 1694, and inner
ledge for 1633 & 1695

\$72 USD

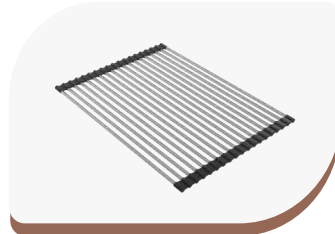

2350 0005 20-1/2" x 12-1/2" x 3/8"
Roller Mat (heat safe stainless steel)
Fits: 1633 (outer ledge), 1500, 1501,
1551, 1602, and 1604

\$72 USD

WORKSTATION SINKS ACCESSORY & PREP BOARD BUNDLES



2370 0001
Accessories Bundle

2350 0001 Roller Mat, 2310 0003 Colander, 2320 0001 Cutting Board
Fits: 1360, 1362, 1627

\$234 USD



2370 0002
Accessories Bundle

2350 0005 Roller Mat, 2310 0008 Colander, 2320 0004 Cutting Board
Fits: 1500, 1501, 1551

\$250 USD



2370 0003
Prep Board

2320 0009 Prep board with knife slots and colanders, 2320 0011 Prep board with 3 solid, round bowls, 2320 0013 Prep board with 3 solid rectangular bowls, 2320 0015 Prep board with 1 prep board and large colander and large mixing bowl
Fits: 1344, 1348, 1360, 1362, 1504, 1505, 1627, 1628

\$370 USD



2370 0004
Prep Board

2320 0008 Prep board with knife slots and colanders, 2320 0010 Prep board with 3 solid, round bowls, 2320 0012 Prep board with 3 solid rectangular bowls, 2320 0014 Prep board with 1 board and large mixing bowl
Fits: 1616, 1618, 1693, 1694, and inner ledge for 1633 & 1695

\$403 USD





SINK RACKS 2.0

- Custom fit to each sink and available in four stunning designer colors.
- Provides a stable base for dishes, while allowing a free flow of water below
- Flexibility to absorb impact from falling dishes and help protect against dish breakage
- Enhanced and enclosed rubber feet protect against scuff marks and prevent water and stain build-up inside of foot

* Stainless Steel/Chrome finished grids are included with the purchase of fireclay kitchen sinks; upgraded finishes are sold separately



SINK RACKS 2.0 FEATURING IMPROVED FEET & STABILITY

Available in 4 Colors.

Standard Color



Stainless Steel (SS)

Premium Colors



Gun Metal (GM)



Matte Black (MB)



Brushed Gold (BG)

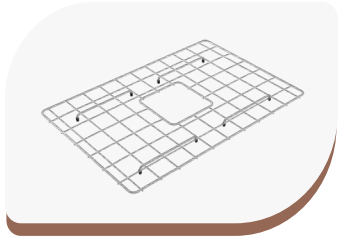

2300 2001

Fits: Contempo 27 (1356-XXX-0120)
Stainless Steel Sink Rack **\$94 USD**
Premium Colors **\$132 USD**

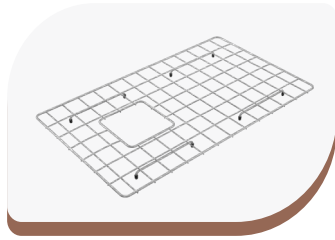

2300 2002

Fits: Contempo 30 (1346-XXX-0120)
Stainless Steel Sink Rack **\$116 USD**
Premium Colors **\$163 USD**

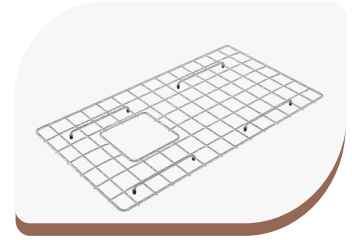

2300 2003

Fits: Contempo Step-Rim 30 (1344-XXX-0120)
Stainless Steel Sink Rack **\$116 USD**
Premium Colors **\$163 USD**

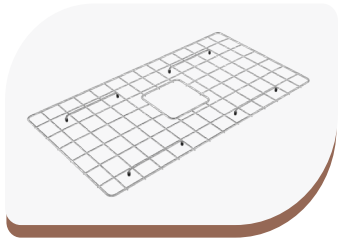

2300 2004

Fits: Vigneto 33 (1353-XXX-0120),
Contempo 33 (1352-XXX-0120)
& Step-Rim 33 (1504-XXX-0120)
Stainless Steel Sink Rack **\$132 USD**
Premium Colors **\$185 USD**

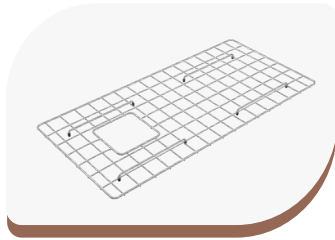

2300 2005

Fits: Contempo 36 (1354-XXX-0120)
& Step-Rim 36 (1505-XXX-0120)
Stainless Steel Sink Rack **\$149 USD**
Premium Colors **\$209 USD**

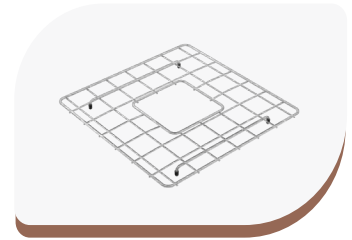

2300 2006

Fits: Contempo Step-Rim 36D
(1348-XXX-0120)
(2 required per sink)
Stainless Steel Sink Rack **\$83 USD**
Premium Colors **\$117 USD**

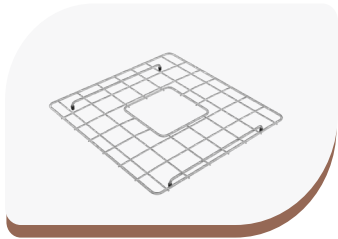

2300 2007

Fits: Contempo 36D (1350-XXX-0120)
(2 required per sink)
Stainless Steel Sink Rack **\$83 USD**
Premium Colors **\$117 USD**

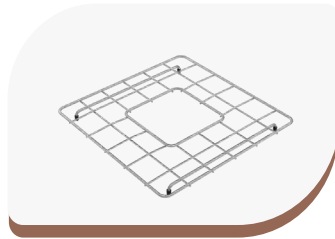

2300 2009

Fits: Sotto 18 (1359-XXX-0120)
Stainless Steel Sink Rack **\$83 USD**
Premium Colors **\$117 USD**

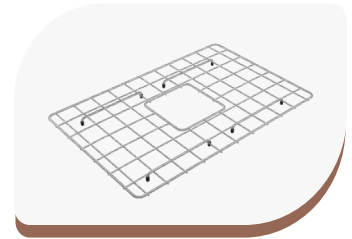

2300 2010

Fits: Sotto 27 (1360-XXX-0120)
Stainless Steel Sink Rack **\$94 USD**
Premium Colors **\$132 USD**

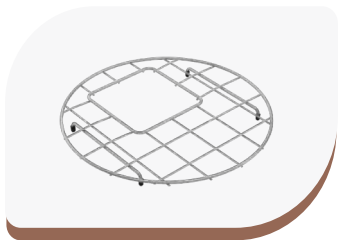

2300 2011

Fits: Sotto 18R (1361-XXX-0120)
Stainless Steel Sink Rack **\$94 USD**
Premium Colors **\$132 USD**

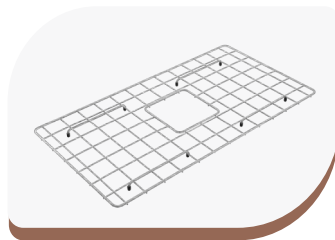

2300 2012

Fits: Sotto 32 (1362-XXX-0120)
Stainless Steel Sink Rack **\$132 USD**
Premium Colors **\$185 USD**

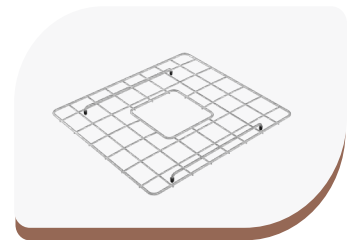

2300 2013

Fits: Classico 20 (1136-XXX-0120)
Stainless Steel Sink Rack **\$105 USD**
Premium Colors **\$147 USD**

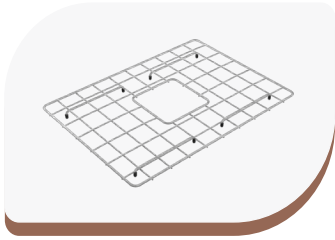
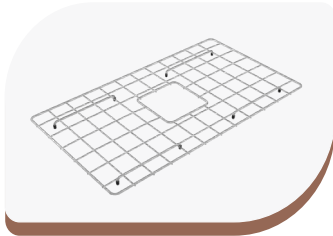
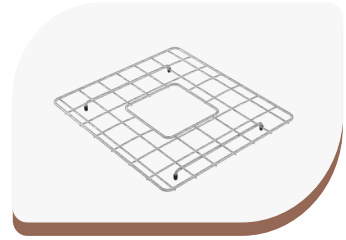
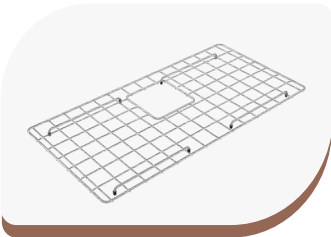
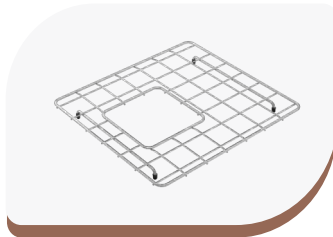
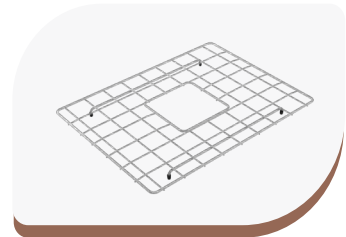
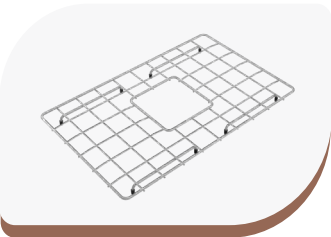
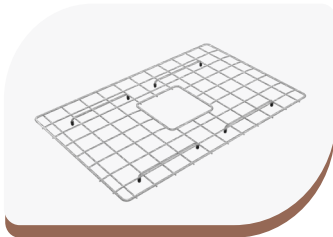
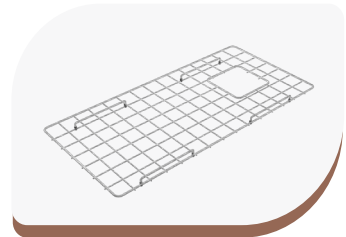
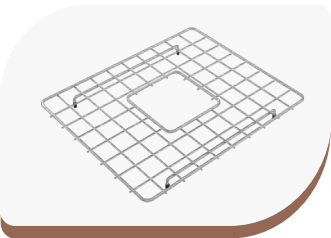
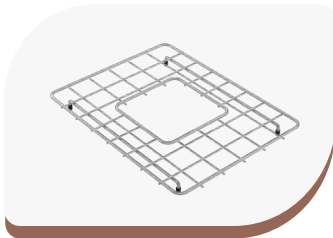
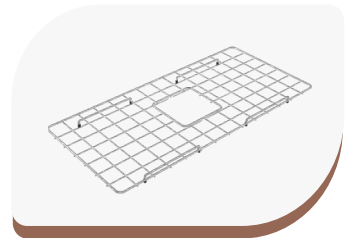
**2300 2014****Fits:** Classico 24 (1137-XXX-0120)Stainless Steel Sink Rack **\$116 USD**
Premium Colors **\$163 USD****2300 2015****Fits:** Classico 30 (1138-XXX-0120)Stainless Steel Sink Rack **\$132 USD**
Premium Colors **\$185 USD****2300 2016****Fits:** Classico 33D (1139-XXX-0120)(2 required per sink)
Stainless Steel Sink Rack **\$83 USD**
Premium Colors **\$117 USD****2300 2035****Fits:** Nuova 34 (1500-XXX-0127)Nuova Pro 34 (1551-XXX-0120)
Stainless Steel Sink Rack **\$132 USD**
Premium Colors **\$185 USD****2300 2036****Fits:** Nuova 34D (1501-XXX-0127)(2 required per sink)
Stainless Steel Sink Rack **\$83 USD**
Premium Colors **\$117 USD****2300 2056****Fits:** Sotto 24 (1627-XXX-0120)Stainless Steel Sink Rack **\$116 USD**
Premium Colors **\$163 USD****2300 2058****Fits:** Baveno 27 (1633-XXX-01XX)Stainless Steel Sink Rack **\$132 USD**
Premium Colors **\$185 USD****2300 2059****Fits:** Contempo Step-Rim 27
(1628-XXX-0120)Stainless Steel Sink Rack **\$132 USD**
Premium Colors **\$185 USD****2300 2069****Fits:** Sotto Step-Rim 34
(1693-XXX-0120)Stainless Steel Sink Rack **\$132 USD**
Premium Colors **\$185 USD****2300 2070****Fits:** Sotto Step-Rim 34D (Large Bowl)
(1694-XXX-0120)Stainless Steel Sink Rack **\$105 USD**
Premium Colors **\$147 USD****2300 2071****Fits:** Sotto Step-Rim 34D (Small Bowl)
(1694-XXX-0120)Stainless Steel Sink Rack **\$83 USD**
Premium Colors **\$117 USD****2300 2072****Fits:** Baveno Hide-Away 34
(1695-XXX-01XX)Stainless Steel Sink Rack **\$132 USD**
Premium Colors **\$185 USD**

FIRECLAY BATHROOM FIXTURES



Food-Safe

Safe for toothpastes
and medicines



BOCCHI Clean+

Easier to clean
& stays clean longer



Heat Proof

Extreme heat from
styling tools or almost
anything



Food-Safe

Safe for toothpastes
and medicines



Super Smooth Surface

19 times smoother
than ordinary Fireclay surface



UV-Protected

Won't fade or discolor



Impact-Resistant

Extremely durable
and scratch resistant









ETNA

Unique line of fine fireclay bathroom sinks with a chic artist's palette shape to the basins.



1075-XXX-0125

Pedestal Sink w/ Monoblock Integrated Base
23" x 17" x 34" 112.46 lbs
comes with a color-matched, pop-up drain & cover

-  1075-001-0125 white \$2,812 USD
-  1075-002-0125 matte white \$3,515 USD
-  1075-004-0125 matte black \$3,515 USD
-  1075-005-0125 black \$3,515 USD
-  1075-010-0125 sapphire blue \$3,515 USD



1115-XXX-0125

Wall-Mounted Sink
35-1/2" x 18" x 4" 50.07 lbs
comes with a color-matched, pop-up drain & cover

-  1115-001-0125 white \$615 USD
-  1115-014-0125 biscuit \$677 USD
-  1115-002-0125 matte white \$769 USD
-  1115-004-0125 matte black \$769 USD
-  1115-005-0125 black \$769 USD
-  1115-006-0125 matte gray \$769 USD
-  1115-010-0125 sapphire blue \$769 USD
-  1115-012-0125 orange \$769 USD
-  1115-029-0125 matte ice blue \$769 USD
-  1115-033-0125 matte mint green \$769 USD



1114-XXX-0125

Vessel Sink
23" x 14-1/2" x 4" 15.37 lbs
comes with a color-matched, pop-up drain & cover

-  1114-001-0125 white \$439 USD
-  1114-014-0125 biscuit \$483 USD
-  1114-002-0125 matte white \$549 USD
-  1114-004-0125 matte black \$549 USD
-  1114-005-0125 black \$549 USD
-  1114-006-0125 matte gray \$549 USD
-  1114-010-0125 sapphire blue \$549 USD
-  1114-012-0125 orange \$549 USD
-  1114-029-0125 matte ice blue \$549 USD
-  1114-033-0125 matte mint green \$549 USD
-  1114-401-0125 platinum \$878 USD
-  1114-403-0125 matte gold \$878 USD



1162-XXX-0125

Monoblock Vessel Sink

23" x 17" x 16" 61 lbs

comes with a color-matched, pop-up drain & cover

	1162-001-0125 white	\$1,406 USD
	1162-014-0125 biscuit	\$1,547 USD
	1162-002-0125 matte white	\$1,758 USD
	1162-004-0125 matte black	\$1,758 USD
	1162-005-0125 black	\$1,758 USD
	1162-006-0125 matte gray	\$1,758 USD
	1162-010-0125 sapphire blue	\$1,758 USD
	1162-012-0125 orange	\$1,758 USD
	1162-029-0125 matte ice blue	\$1,758 USD
	1162-033-0125 matte mint green	\$1,758 USD





7712-XXXX-1162

Wooden Bench

47" x 20" x 16" 50 lbs

bench only, sink sold separately; pre-cut to fit plumbing

	7712-1610-1162 matte gray finish	\$1,600 USD
	7712-1710-1162 walnut finish	\$1,600 USD





FENICE

Unique minimalist line of fine fireclay bathroom sinks with multiple base options.



1489-XXX-0126

Vessel Sink

21-3/4" x 17-3/4" x 5-1/2" 19.71 lbs
single-hole faucet setting, w/out overflow

-  1489-001-0126 white \$438 USD
-  1489-014-0126 biscuit \$482 USD
-  1489-002-0126 matte white \$548 USD
-  1489-004-0126 matte black \$548 USD
-  1489-005-0126 black \$548 USD
-  1489-006-0126 matte gray \$548 USD
-  1489-010-0126 sapphire blue \$548 USD
-  1489-012-0126 orange \$548 USD
-  1489-029-0126 matte ice blue \$548 USD
-  1489-033-0126 matte mint green \$548 USD



1490-XXX-0126

Wall-Mounted Sink

35-1/2" x 18" x 5-1/2" 40.74 lbs
single-hole faucet setting, w/out overflow; may be set on counter, used with metal console legs or Fenice furniture base



-  1490-001-0126 white \$514 USD
-  1490-014-0126 biscuit \$566 USD
-  1490-002-0126 matte white \$643 USD
-  1490-004-0126 matte black \$643 USD
-  1490-005-0126 black \$643 USD
-  1490-006-0126 matte gray \$643 USD
-  1490-010-0126 sapphire blue \$643 USD
-  1490-012-0126 orange \$643 USD
-  1490-029-0126 matte ice blue \$643 USD
-  1490-033-0126 matte mint green \$643 USD



7008-XXXX-1490

Wall-Hung Cabinet Base

33"L x 18-1/2"D x 17-1/4"H 49 lbs
Sink sold separately, compatible with 1490-XXX-0126 sink only; height and weight is without sink; drawers feature drain guides and soft close glides

-  7008-0157-1490 white \$1,234 USD
-  7008-2058-1490 anthracite \$1,234 USD

3930 0001 XX

Metal Console Leg Base

31" tall 12.5 lbs
compatible with Fenice 1490 sinks



-  3930 0001 S - Satin Nickel \$721 USD
-  3930 0001 F - Matte Black \$794 USD
-  3930 0001 G - Matte Gold \$1,082 USD

BOCCHI Co. reserves the right to make changes to colors/finishes, dimensions and prices of the products at any time. Colors/finishes may look different in real life. Product must be seen for actual color/finish example.



FIRENZE

Unique fine fireclay vessel sinks and sleek wall-hung toilets to add style to any room.







1304-XXX-0129

Wall-Hung Toilet Bowl

13-1/2" x 21" x adjustable height 65.54 lbs

vitreous china; use with A0332-XXX seat only; in-wall tank sold separately compatible with standard and dual flush models

	1304-001-0129 white	\$439 USD
	1304-014-0129 biscuit	\$483 USD
	1304-002-0129 matte white	\$549 USD
	1304-004-0129 matte black	\$549 USD
	1304-005-0129 black	\$549 USD







A0332-XXX

Soft-Close Toilet Seat

Ultra-slim with squared front, 5 lbs

compatible with 1304-XXX-0129 toilet only

	A0332-001 white	\$178 USD
	A0332-014 biscuit	\$196 USD
	A0332-002 matte white	\$223 USD
	A0332-004 matte black	\$223 USD
	A0332-005 black	\$223 USD



1074-XXX-0126

Vessel Sink

20" x 16-1/2" x 5-1/2" 29.00 lbs

single-hole faucet setting, w/out overflow

	1074-001-0126 white	\$332 USD
	1074-014-0126 biscuit	\$366 USD
	1074-002-0126 matte white	\$415 USD
	1074-004-0126 matte black	\$415 USD
	1074-005-0126 black	\$415 USD
	1074-006-0126 matte gray	\$415 USD
	1074-010-0126 sapphire blue	\$415 USD
	1074-012-0126 orange	\$415 USD
	1074-029-0126 matte ice blue	\$415 USD
	1074-033-0126 matte mint green	\$415 USD



LAVITA

Timelessly elegant, wall-hung console sink in fine fireclay.

Mix-and-match tops with metal or fireclay leg sets.







1168-XXX-0127

Wall-Hung Console Sink Top

40" x 19-3/4" x 33.5" 61.01 lbs

3-hole faucet setting (8"), w/ overflow, compatible with 1169-XXX-0320 leg set and 3930-0001-XX Metal Console Legs

-  1168-001-0127 white \$601 USD
-  1168-014-0127 biscuit \$662 USD
-  1168-002-0127 matte white \$752 USD
-  1168-004-0127 matte black \$752 USD
-  1168-005-0127 black \$752 USD









1169-XXX-0320

Fireclay Leg Set

31" tall 11.00 lbs

2 legs per set, compatible with 1168-XXX-0127 top only

-  1169-001-0320 white \$422 USD
-  1169-014-0320 biscuit \$465 USD
-  1169-002-0320 matte white \$528 USD
-  1169-004-0320 matte black \$528 USD
-  1169-005-0320 black \$528 USD
-  1169-401-0320 platinum \$844 USD
-  1169-403-0320 matte gold \$844 USD



3930 0001 XX

Metal Console Leg Base

31" tall 12.5 lbs

compatible with Lavita 1168 sinks



-  3930 0001 S - Satin Nickel \$721 USD
-  3930 0001 F - Matte Black \$794 USD
-  3930 0001 G - Matte Gold \$1,082 USD



MILANO

Sleek fine fireclay sinks that can be wall-hung, counter set, or installed with metal console legs.













1376-XXX-012X

Wall-Hung Sink

24" x 18-1/3" x 4-3/4" 34.92 lbs

single-hole faucet setting (end code -0126); 3-hole faucet setting (end code -0127); with overflow; may be set on counter or used with metal console legs

-  1376-001-012x white \$349 USD
-  1376-014-012x biscuit \$384 USD
-  1376-002-012x matte white \$437 USD
-  1376-004-012x matte black \$437 USD
-  1376-005-012x black \$437 USD

-  1376-006-012x matte gray \$437 USD
-  1376-010-012x sapphire blue \$437 USD
-  1376-012-012x orange \$437 USD
-  1376-029-012x matte ice blue \$437 USD
-  1376-033-012x matte mint green \$437 USD



1377-XXX-012X

Wall-Hung Sink

32" x 18-1/3" x 4-3/4" 48.28 lbs

single-hole faucet setting (end code -0126); 3-hole faucet setting (end code -0127); with overflow; may be set on counter or used with metal console legs

-  1377-001-012x white \$377 USD
-  1377-014-012x biscuit \$415 USD
-  1377-002-012x matte white \$472 USD
-  1377-004-012x matte black \$472 USD
-  1377-005-012x black \$472 USD
-  1377-006-012x matte gray \$472 USD
-  1377-010-012x sapphire blue \$472 USD
-  1377-012-012x orange \$472 USD
-  1377-029-012x matte ice blue \$472 USD
-  1377-033-012x matte mint green \$472 USD



1378-XXX-012X

Wall-Hung Sink

40" x 18-1/3" x 5-1/4" 59.88 lbs

single-hole faucet setting (end code -0126); 3-hole faucet setting (end code -0127); with overflow; may be set on counter or used with metal console legs

-  1378-001-012x white \$460 USD
-  1378-014-012x biscuit \$506 USD
-  1378-002-012x matte white \$575 USD
-  1378-004-012x matte black \$575 USD
-  1378-005-012x black \$575 USD
-  1378-006-012x matte gray \$575 USD
-  1378-010-012x sapphire blue \$575 USD
-  1378-012-012x orange \$575 USD
-  1378-029-012x matte ice blue \$575 USD
-  1378-033-012x matte mint green \$575 USD





1393-XXX-0132

Wall-Hung Sink

47-1/2" x 18-1/2" x 5-1/4" 72.53 lbs

double basin each with a single-hole faucet setting; with overflow; may be set on counter or used with metal console legs

- 1393-001-0132 white \$660 USD
- 1393-014-0132 biscuit \$726 USD
- 1393-002-0132 matte white \$825 USD
- 1393-004-0132 matte black \$825 USD
- 1393-005-0132 black \$825 USD
- 1393-006-0132 matte gray \$825 USD
- 1393-010-0132 sapphire blue \$825 USD
- 1393-012-0132 orange \$825 USD
- 1393-029-0132 matte ice blue \$825 USD
- 1393-033-0132 matte mint green \$825 USD



1394-XXX-012X

Wall-Hung Sink

47-1/2" x 18-1/2" x 5-1/4" 67.90 lbs

single-hole faucet setting (end code -0126); 3-hole faucet setting (end code -0127); with overflow; may be set on counter or used with metal console legs

- 1394-001-012x white \$660 USD
- 1394-014-012x biscuit \$726 USD
- 1394-002-012x matte white \$825 USD
- 1394-004-012x matte black \$825 USD
- 1394-005-012x black \$825 USD
- 1394-006-012x matte gray \$825 USD
- 1394-010-012x sapphire blue \$825 USD
- 1394-012-012x orange \$825 USD
- 1394-029-012x matte ice blue \$825 USD
- 1394-033-012x matte mint green \$825 USD



3930 0001 XX

Metal Console Leg Base

31" tall 12.5 lbs

compatible with Milano 1376, 1377, 1378, 1393, and 1394 sinks

- 3930 0001 S - Satin Nickel \$721 USD
- 3930 0001 F - Matte Black \$794 USD
- 3930 0001 G - Matte Gold \$1,082 USD



MILANO (cont.)





Sleek, space saving options that bring big style to any room.



1632-XXX-0129

Wall-Hung Elongated Toilet Bowl
13-1/2" x 21" x adjustable height 62.25 lbs

vitreous china, compatible with standard USA elongated seats (sold separately); In-wall tank also sold separately compatible with standard and dual flush models

	1632-001-0129 white	\$449 USD
	1632-014-0129 biscuit	\$494 USD
	1632-002-0129 matte white	\$562 USD
	1632-004-0129 matte black	\$562 USD
	1632-005-0129 black	\$562 USD



1392-XXX-0126

Corner Wall-Hung Sink

12" x 12" x 4" 8.2 lbs
single-hole faucet setting; with overflow





	1392-001-0126 white	\$157 USD
	1392-014-0126 biscuit	\$173 USD
	1392-002-0126 matte white	\$197 USD
	1392-004-0126 matte black	\$197 USD
	1392-005-0126 black	\$197 USD
	1392-006-0126 matte gray	\$197 USD
	1392-010-0126 sapphire blue	\$197 USD
	1392-012-0126 orange	\$197 USD
	1392-029-0126 matte ice blue	\$197 USD
	1392-033-0126 matte mint green	\$197 USD



A0337-XXX

Soft-Close Toilet Seat
Elongated front, 5 lbs

compatible with 1632-XXX-0129 toilet and other standard elongated models

	A0337-001 white	\$178 USD
	A0337-014 biscuit	\$196 USD
	A0337-002 matte white	\$223 USD
	A0337-004 matte black	\$223 USD
	A0337-005 black	\$223 USD





1418-XXX-0126

Wall-Hung Sink

14-3/4" x 9" x 4-1/2" 13.10 lbs

single-hole faucet setting on left-side-facing; w/out overflow; may be set on counter or used with Piccolo wall-cabinet

-  1418-001-0126 white \$146 USD
-  1418-014-0126 biscuit \$161 USD
-  1418-002-0126 matte white \$183 USD
-  1418-004-0126 matte black \$183 USD
-  1418-005-0126 black \$183 USD
-  1418-006-0126 matte gray \$183 USD
-  1418-010-0126 sapphire blue \$183 USD
-  1418-012-0126 orange \$183 USD
-  1418-029-0126 matte ice blue \$183 USD
-  1418-033-0126 matte mint green \$183 USD



1419-XXX-0126

Wall-Hung Sink

14-3/4" x 9" x 4-1/2" 13.10 lbs

single-hole faucet setting on right-side-facing; w/out overflow; may be set on counter or used with Piccolo wall-cabinet

-  1419-001-0126 white \$146 USD
-  1419-014-0126 biscuit \$161 USD
-  1419-002-0126 matte white \$183 USD
-  1419-004-0126 matte black \$183 USD
-  1419-005-0126 black \$183 USD
-  1419-006-0126 matte gray \$183 USD
-  1419-010-0126 sapphire blue \$183 USD
-  1419-012-0126 orange \$183 USD
-  1419-029-0126 matte ice blue \$183 USD
-  1419-033-0126 matte mint green \$183 USD





7020-XXXX-1418

Wall-Hung Cabinet Base

14-1/2"L x 9"D x 17-3/4"H 18 lbs

Sink sold separately, compatible with 1418-XXX-0126 sink only; height and weight is without sink; door is hinged on the left

-  7020-0101-1418 white \$407 USD
-  7020-2009-1418 anthracite \$407 USD





7020-XXXX-1419

Wall-Hung Cabinet Base

14-1/2"L x 9"D x 17-3/4"H 18 lbs

Sink sold separately, compatible with 1419-XXX-0126 sink only; height and weight is without sink; door is hinged on the right

-  7020-0101-1419 white \$407 USD
-  7020-2009-1419 anthracite \$407 USD



PARMA







Gently curving fine fireclay sinks that can be wall-hung, counter set, or installed with metal console legs.



1123-XXX-012X

Wall-Hung Sink

25-2/3" x 19-2/3" x 5" 47.02 lbs
single-hole faucet setting (end code-0126); 3-hole faucet setting (end code -0127); with overflow (not pictured); may be set on counter or used with metal console legs







	1123-001-012X white	\$298 USD
	1123-014-012X biscuit	\$328 USD
	1123-002-012X matte white	\$373 USD
	1123-004-012x matte black	\$373 USD
	1123-005-012X black	\$373 USD
	1123-010-012X sapphire blue	\$373 USD



1124-XXX-012X

Wall-Hung Sink

33-2/3" x 19-2/3" x 5" 58.07 lbs
single-hole faucet setting (end code -0126); 3-hole faucet setting (end code -0127); with overflow; may be set on counter or used with metal console legs







	1124-001-012X white	\$384 USD
	1124-014-012X biscuit	\$423 USD
	1124-002-012X matte white	\$480 USD
	1124-004-012X matte black	\$480 USD
	1124-005-012X black	\$480 USD
	1124-010-012X sapphire blue	\$480 USD



1122-XXX-0126

Wall-Hung Sink

19-2/3" x 19-2/3" x 5" 34.50 lbs
single-hole faucet setting; with overflow (not pictured); may be set on counter, NOT for use with metal console legs

	1122-001-0126 white	\$168 USD
	1122-014-0126 biscuit	\$185 USD
	1122-002-0126 matte white	\$210 USD
	1122-004-0126 matte black	\$210 USD
	1122-005-0126 black	\$210 USD
	1122-010-0126 sapphire blue	\$210 USD

3930 0001 XX

Metal Console Leg Base

31" tall 12.5 lbs
compatible with Parma 1123 or 1124 sinks

	3930 0001 S - Satin Nickel	\$721 USD
	3930 0001 F - Matte Black	\$794 USD
	3930 0001 G - Matte Gold	\$1,082 USD





1384-XXX-0125
Undermount Sink
 22" x 17-1/2" x 5-3/4" 17.86 lbs
 undermount bathroom sink with overflow (reversible)

- | | | |
|---|-----------------------------|-----------|
|  | 1384-001-0125 white | \$161 USD |
|  | 1384-014-0125 biscuit | \$178 USD |
|  | 1384-002-0125 matte white | \$202 USD |
|  | 1384-004-0125 matte black | \$202 USD |
|  | 1384-005-0125 black | \$202 USD |
|  | 1384-010-0125 sapphire blue | \$202 USD |
|  | 1384-401-0125 platinum | \$388 USD |
|  | 1384-403-0125 matte gold | \$388 USD |



RAVENNA

Slim fine fireclay sinks that can be wall-hung, recessed into counter, installed with metal console legs, or with select cabinet bases.







1113-XXX-012X

Wall-Hung Sink

32" x 18-3/4" x 4" 44.71 lbs

single-hole faucet setting (end code -0126); 3-hole faucet setting (end code -0127); with overflow; may recessed into counter or used with metal console legs; NOT compatible with furniture base

	1113-001-012X white	\$383 USD
	1113-002-012X matte white	\$479 USD
	1113-004-012X matte black	\$479 USD
	1113-005-012X black	\$479 USD







1105-XXX-012X

Wall-Hung Sink

40-1/2" x 18-3/4" x 4" 57.67 lbs

single-hole faucet setting (end code -0126); 3-hole faucet setting (end code -0127); with overflow; may recessed into counter or used with metal console legs; compatible with select furniture bases

	1105-001-012X white	\$459 USD
	1105-002-012X matte white	\$574 USD
	1105-004-012X matte black	\$574 USD
	1105-005-012X black	\$574 USD







1161-XXX-012X

Wall-Hung Sink

24-1/2" x 19" x 4" 34.13 lbs

single-hole faucet setting (end code -0126); 3-hole faucet setting (end code -0127); with overflow; may recessed into counter or used with metal console legs; compatible with select furniture bases

	1161-001-012X white	\$289 USD
	1161-002-012X matte white	\$362 USD
	1161-004-012X matte black	\$362 USD
	1161-005-012X black	\$362 USD







1111-XXX-0132

Wall-Hung Sink

48" x 18-3/4" x 4" 68.54 lbs

double basin each with a single-hole faucet setting; with overflow (not pictured); may recessed into counter or used with metal console legs; NOT compatible with furniture base

-  1111-001-0132 white \$660 USD
-  1111-002-0132 matte white \$825 USD
-  1111-004-0132 matte black \$825 USD
-  1111-005-0132 black \$825 USD



3930 0001 XX

Metal Console Leg Base

31" tall 12.5 lbs

compatible Ravenna 1105, 1111, 1113 and 1161 sinks

-  3930 0001 S - Satin Nickel \$721 USD
-  3930 0001 F - Matte Black \$794 USD
-  3930 0001 G - Matte Gold \$1,082 USD





7019-XXXX-1105

Wall-Hung Cabinet Base

39-1/2"L x 18-1/2"D x 17-1/4"H 89 lbs

Sink sold separately, compatible with 1105-xxx-012x sinks only; height and weight is without sink; drawers feature drain guides and soft close glides

- 7019-0109-1105 white \$1,131 USD
- 7019-2017-1105 anthracite \$1,131 USD



7019-XXXX-1161

Wall-Hung Cabinet Base

23-3/4"L x 18-1/2"D x 13-3/4"H 38 lbs

Sink sold separately, compatible with 1161-xxx-012x sinks only; height and weight is without sink; drawers feature drain guides and soft close glides

- 7019-0101-1161 white \$871 USD
- 7019-2009-1161 anthracite \$871 USD





SCALA

Rectangular fine fireclay sinks with undermount installation that add sophistication to any bathroom.



1006-XXX-0125
Undermount Sink
21-1/2" x 16" x 7-1/4" 21.32 lbs
undermount bathroom sink with overflow

- | | | |
|---|-----------------------------|-----------|
|  | 1006-001-0125 white | \$161 USD |
|  | 1006-014-0125 biscuit | \$178 USD |
|  | 1006-002-0125 matte white | \$202 USD |
|  | 1006-004-0125 matte black | \$202 USD |
|  | 1006-005-0125 black | \$202 USD |
|  | 1006-010-0125 sapphire blue | \$202 USD |
|  | 1006-401-0125 platinum | \$312 USD |
|  | 1006-403-0125 matte gold | \$312 USD |



SCALA ARCH

Elegant fine fireclay sinks that can be wall-hung, counter set, installed with metal console legs, or with cabinet base.



1076-XXX-0126

Wall-Hung Sink

19" x 19" x 4" 36.24 lbs

single-hole faucet setting; with overflow; may be set on counter or used with metal console legs; NOT compatible with furniture base

	1076-001-0126 white	\$221 USD
	1076-014-0126 biscuit	\$244 USD
	1076-002-0126 matte white	\$277 USD
	1076-004-0126 matte black	\$277 USD
	1076-005-0126 black	\$277 USD
	1076-006-0126 matte gray	\$277 USD
	1076-010-0126 sapphire blue	\$277 USD
	1076-012-0126 orange	\$277 USD
	1076-029-0126 matte ice blue	\$277 USD
	1076-033-0126 matte mint green	\$277 USD



1077-XXX-012X

Wall-Hung Sink

23-3/4" x 19" x 4" 41.09 lbs

single-hole faucet setting (end code -0126); 3-hole faucet setting (end code -0127); with overflow; may be set on counter or used with metal console legs; NOT compatible with furniture base

	1077-001-012X white	\$271 USD
	1077-014-012X biscuit	\$299 USD
	1077-002-012X matte white	\$339 USD
	1077-004-012X matte black	\$339 USD
	1077-005-012X black	\$339 USD
	1077-006-012X matte gray	\$339 USD
	1077-010-012X sapphire blue	\$339 USD
	1077-012-012X orange	\$339 USD
	1077-029-012X matte ice blue	\$339 USD
	1077-033-012X matte mint green	\$339 USD



1078-XXX-012X

Wall-Hung Sink

31-1/2" x 19" x 4" 51.92 lbs

single-hole faucet setting (end code -0126); 3-hole faucet setting (end code -0127); with overflow; may be set on counter or used with metal console legs; NOT compatible with furniture base

	1078-001-012x white	\$321 USD
	1078-014-012x biscuit	\$354 USD
	1078-002-012x matte white	\$402 USD
	1078-004-012x matte black	\$402 USD
	1078-005-012x black	\$402 USD
	1078-006-012x matte gray	\$402 USD
	1078-010-012x sapphire blue	\$402 USD
	1078-012-012x orange	\$402 USD
	1078-029-012x matte ice blue	\$402 USD
	1078-033-012x matte mint green	\$402 USD



1079-XXX-012X

Wall-Hung Sink

40" x 19" x 4" 76.99 lbs

single-hole faucet setting (end code -0126); 3-hole faucet setting (end code -0127); with overflow; may be set on counter or used with metal console legs; may be used with furniture base

	1079-001-012x white	\$440 USD
	1079-014-012x biscuit	\$484 USD
	1079-002-012x matte white	\$550 USD
	1079-004-012x matte black	\$550 USD
	1079-005-012x black	\$550 USD
	1079-006-012x matte gray	\$550 USD
	1079-010-012x sapphire blue	\$550 USD
	1079-012-012x orange	\$550 USD
	1079-029-012x matte ice blue	\$550 USD
	1079-033-012x matte mint green	\$550 USD





7006-XXXX-1077

Wall-Hung Cabinet Base

23-3/4"L x 18-1/2"D x 11-3/4"H 38 lbs

Sink sold separately, compatible with 1077-xxx 012x sinks only; height and weight is without sink; drawers feature drain guides and soft close glides

	7006-0106-1077 white	\$773 USD
	7006-2008-1077 anthracite	\$773 USD





7006-XXXX-1079

Wall-Hung Cabinet Base

38-3/4"L x 18-1/2"D x 16-1/2"H 89 lbs

Sink sold separately, compatible with 1079-xxx-012x sinks only; height and weight is without sink; drawers feature drain guides and soft close glides; anthracite has a stainless steel face on top drawer

	7006-0122-1079 white	\$1,131 USD
	7006-0824-1079 anthracite	\$1,131 USD



3930 0001 XX

Metal Console Leg Base

31" tall 12.5 lbs

Compatible with Scala Arch 1076, 1077, 1078, and 1079 sinks

	3930 0001 S - Satin Nickel	\$721 USD
	3930 0001 F - Matte Black	\$794 USD
	3930 0001 G - Matte Gold	\$1,082 USD



SOTTILE

Unique line of fine fireclay vessel sinks with elegantly arching sides.



1470-XXX-0126

Vessel Sink

12" x 9" x 5" 9.2 lbs

single-hole faucet setting; without overflow; optional color-matched drain & cover sold separately

	1470-001-0126 white	\$146 USD
	1470-014-0126 biscuit	\$161 USD
	1470-002-0126 matte white	\$183 USD
	1470-004-0126 matte black	\$183 USD
	1470-005-0126 black	\$183 USD
	1470-006-0126 matte gray	\$183 USD
	1470-010-0126 sapphire blue	\$183 USD
	1470-012-0126 orange	\$183 USD
	1470-029-0126 matte ice blue	\$183 USD
	1470-033-0126 matte mint green	\$183 USD
	1470-401-0126 platinum	\$292 USD
	1470-403-0126 matte gold	\$292 USD

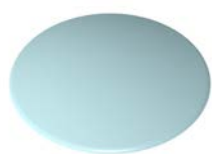

1219-XXX

Pop-Up Drain and Color-matched Cover

compatible with standard USA drain sizes; cover is actual color-matched fireclay; sold separately; fits all Sottile vessels

	1219-001 white	\$70 USD		1219-010 sapphire blue	\$70 USD
	1219-014 biscuit	\$70 USD		1219-012 orange	\$70 USD
	1219-002 matte white	\$70 USD		1219-029 matte ice blue	\$70 USD
	1219-004 matte black	\$70 USD		1219-033 matte mint green	\$70 USD
	1219-005 black	\$70 USD		1219-401 platinum	\$70 USD
	1219-006 matte gray	\$70 USD		1219-403 matte gold	\$70 USD



1471-XXX-0125

Vessel Sink

Ø 10.24" x 4.72" 5 lbs

without overflow; optional color-matched drain & cover sold separately

	1471-001-0125 white	\$146 USD
	1471-014-0125 biscuit	\$161 USD
	1471-002-0125 matte white	\$183 USD
	1471-004-0125 matte black	\$183 USD
	1471-005-0125 black	\$183 USD
	1471-006-0125 matte gray	\$183 USD
	1471-010-0125 sapphire blue	\$183 USD
	1471-012-0125 orange	\$183 USD
	1471-029-0125 matte ice blue	\$183 USD
	1471-033-0125 matte mint green	\$183 USD
	1471-401-0125 platinum	\$292 USD
	1471-403-0125 matte gold	\$292 USD





1476-XXX-0125

Vessel Sink

21-1/2" x 15" x 5" 27.00 lbs

without overflow; optional color-matched drain & cover sold separately

	1476-001-0125 white	\$541	USD
	1476-014-0125 biscuit	\$596	USD
	1476-002-0125 matte white	\$677	USD
	1476-004-0125 matte black	\$677	USD
	1476-005-0125 black	\$677	USD
	1476-006-0125 matte gray	\$677	USD
	1476-010-0125 sapphire blue	\$677	USD
	1476-012-0125 orange	\$677	USD
	1476-029-0125 matte ice blue	\$677	USD
	1476-033-0125 matte mint green	\$677	USD
	1476-401-0125 platinum	\$1,082	USD
	1476-403-0125 matte gold	\$1,082	USD



1477-XXX-0125

Vessel Sink

15-1/4" x 15" x 5" 21.51 lbs

without overflow; optional color-matched drain & cover sold separately

	1477-001-0125 white	\$541	USD
	1477-014-0125 biscuit	\$596	USD
	1477-002-0125 matte white	\$677	USD
	1477-004-0125 matte black	\$677	USD
	1477-005-0125 black	\$677	USD
	1477-006-0125 matte gray	\$677	USD
	1477-010-0125 sapphire blue	\$677	USD
	1477-012-0125 orange	\$677	USD
	1477-029-0125 matte ice blue	\$677	USD
	1477-033-0125 matte mint green	\$677	USD
	1477-401-0125 platinum	\$1,082	USD
	1477-403-0125 matte gold	\$1,082	USD



1478-XXX-0125

Vessel Sink

ø 15" x 5" 17.09 lbs

without overflow; optional color-matched drain & cover sold separately

	1478-001-0125 white	\$433	USD
	1478-014-0125 biscuit	\$477	USD
	1478-002-0125 matte white	\$542	USD
	1478-004-0125 matte black	\$542	USD
	1478-005-0125 black	\$542	USD
	1478-006-0125 matte gray	\$542	USD
	1478-010-0125 sapphire blue	\$542	USD
	1478-012-0125 orange	\$542	USD
	1478-029-0125 matte ice blue	\$542	USD
	1478-033-0125 matte mint green	\$542	USD
	1478-401-0125 platinum	\$866	USD
	1478-403-0125 matte gold	\$866	USD



1479-XXX-0126

Vessel Sink

23-1/2" x 15" x 4-1/2" 24.47 lbs

single-hole faucet setting; with overflow; optional color-matched drain & cover sold separately (reversible)

	1479-001-0126 white	\$481	USD
	1479-014-0126 biscuit	\$530	USD
	1479-002-0126 matte white	\$602	USD
	1479-004-0126 matte black	\$602	USD
	1479-005-0126 black	\$602	USD
	1479-006-0126 matte gray	\$602	USD
	1479-010-0126 sapphire blue	\$602	USD
	1479-012-0126 orange	\$602	USD
	1479-029-0126 matte ice blue	\$602	USD
	1479-033-0126 matte mint green	\$602	USD
	1479-401-0126 platinum	\$962	USD
	1479-403-0126 matte gold	\$962	USD





1494-XXX-0125

Vessel Sink

Ø 15" x 5" 8.3 lbs

without overflow; optional color-matched drain & cover sold separately

	1494-001-0125 white	\$433 USD
	1494-014-0125 biscuit	\$477 USD
	1494-002-0125 matte white	\$542 USD
	1494-004-0125 matte black	\$542 USD
	1494-005-0125 black	\$542 USD
	1494-006-0125 matte gray	\$542 USD
	1494-010-0125 sapphire blue	\$542 USD
	1494-012-0125 orange	\$542 USD
	1494-029-0125 matte ice blue	\$542 USD
	1494-033-0125 matte mint green	\$542 USD
	1494-401-0125 platinum	\$866 USD
	1494-403-0125 matte gold	\$866 USD



1521-XXX-0125

Vessel Sink

22" x 14" x 4.5" 14.5 lbs

without overflow; optional color-matched drain & cover sold separately

	1521-001-0125 white	\$541 USD
	1521-014-0125 biscuit	\$596 USD
	1521-002-0125 matte white	\$677 USD
	1521-004-0125 matte black	\$677 USD
	1521-005-0125 black	\$677 USD
	1521-006-0125 matte gray	\$677 USD
	1521-010-0125 sapphire blue	\$677 USD
	1521-012-0125 orange	\$677 USD
	1521-029-0125 matte ice blue	\$677 USD
	1521-033-0125 matte mint green	\$677 USD
	1521-401-0125 platinum	\$1,082 USD
	1521-403-0125 matte gold	\$1,082 USD



1598-XXX-0126

Vessel Sink

18" x 18" x 4.5" 18.7 lbs

single-hole faucet setting; without overflow; optional color-matched drain & cover sold separately

	1598-001-0126 white	\$258 USD
	1598-014-0126 biscuit	\$284 USD
	1598-002-0126 matte white	\$323 USD
	1598-004-0126 matte black	\$323 USD
	1598-005-0126 black	\$323 USD
	1598-006-0126 matte gray	\$323 USD
	1598-010-0126 sapphire blue	\$323 USD
	1598-012-0126 orange	\$323 USD
	1598-029-0126 matte ice blue	\$323 USD
	1598-033-0126 matte mint green	\$323 USD
	1598-401-0126 platinum	\$516 USD
	1598-403-0126 matte gold	\$516 USD



1599-XXX-0126

Vessel Sink

Ø 18" x 4.5" 8.4 lbs

single-hole faucet setting; without overflow; optional color-matched drain & cover sold separately

	1599-001-0126 white	\$258 USD
	1599-014-0126 biscuit	\$284 USD
	1599-002-0126 matte white	\$323 USD
	1599-004-0126 matte black	\$323 USD
	1599-005-0126 black	\$323 USD
	1599-006-0126 matte gray	\$323 USD
	1599-010-0126 sapphire blue	\$323 USD
	1599-012-0126 orange	\$323 USD
	1599-029-0126 matte ice blue	\$323 USD
	1599-033-0126 matte mint green	\$323 USD
	1599-401-0126 platinum	\$516 USD
	1599-403-0126 matte gold	\$516 USD



1600-XXX-0126

Vessel Sink

24" x 18" x 4.5" 16.5 lbs

single-hole faucet setting; without overflow; optional color-matched drain & cover sold separately

	1600-001-0126 white	\$481 USD
	1600-014-0126 biscuit	\$530 USD
	1600-002-0126 matte white	\$602 USD
	1600-004-0126 matte black	\$602 USD
	1600-005-0126 black	\$602 USD
	1600-006-0126 matte gray	\$602 USD
	1600-010-0126 sapphire blue	\$602 USD
	1600-012-0126 orange	\$602 USD
	1600-029-0126 matte ice blue	\$602 USD
	1600-033-0126 matte mint green	\$602 USD
	1600-401-0126 platinum	\$962 USD
	1600-403-0126 matte gold	\$962 USD



TAORMINA



Classically styled fine fireclay sinks with pedestal and trap covers bases. May also be set into the counter.



1007-XXX-012X

Pedestal Sink Top

26" x 19" x 32" (with pedestal base) 37.79 lbs
single-hole faucet setting (end code -0126); 3-hole faucet setting (end code -0127); with overflow; may be recessed into counter or used with Taormina trap cover or pedestal bases

-  1007-001-012X white \$243 USD
-  1007-014-012X biscuit \$268 USD
-  1007-002-012X matte white \$305 USD





1002-XXX-0320

Pedestal Base

27-1/4" Tall 22.92 lbs

pedestal base hides drain pipes; compatible with 1007-XXX-012X and 1008-XXX-012X Taormina sink tops only



-  1002-001-0320 white \$153 USD
-  1002-014-0320 biscuit \$168 USD
-  1002-002-0320 matte white \$192 USD



1008-XXX-012X

Pedestal Sink Top

33-1/2" x 19" x 32" (with pedestal base) 49.60 lbs
single-hole faucet setting (end code -0126); 3-hole faucet setting (end code -0127); with overflow; may be recessed into counter or used with Taormina trap cover or pedestal bases

-  1008-001-012X white \$314 USD
-  1008-014-012X biscuit \$346 USD
-  1008-002-012X matte white \$393 USD





1003-XXX-0338

Trap Cover

14-1/4" Tall 17.35 lbs

wall-hung trap cover hides drain pipes, allows for flexible height placement of sink; compatible with 1007-XXX-012X and 1008-XXX-012X Taormina sink tops only

-  1003-001-0338 white \$137 USD
-  1003-014-0338 biscuit \$147 USD
-  1003-002-0338 matte white \$167 USD



ENEZIA

Classic fine fireclay vessel sinks in an array of unique colors and finishes.



1120-XXX-0125

Vessel Sink

ø 15.75" x 4" 10.71 lbs

without overflow; optional color-matched drain & cover sold separately

	1120-001-0125 white	\$332 USD		1120-010-0125 sapphire blue	\$415 USD
	1120-014-0125 biscuit	\$366 USD		1120-012-0125 orange	\$415 USD
	1120-002-0125 matte white	\$415 USD		1120-029-0125 matte ice blue	\$415 USD
	1120-004-0125 matte black	\$415 USD		1120-033-0125 matte mint green	\$415 USD
	1120-005-0125 black	\$415 USD		1120-401-0125 platinum	\$664 USD
	1120-006-0125 matte gray	\$415 USD		1120-403-0125 matte gold	\$664 USD



1219-XXX

Pop-Up Drain and Color-matched Cover

compatible with standard USA drain sizes; cover is actual color-matched fireclay; sold separately; fits all Venezia vessels

	1219-001 white	\$70 USD
	1219-014 biscuit	\$70 USD
	1219-002 matte white	\$70 USD
	1219-004 matte black	\$70 USD
	1219-005 black	\$70 USD
	1219-006 matte gray	\$70 USD
	1219-010 sapphire blue	\$70 USD
	1219-012 orange	\$70 USD
	1219-029 matte ice blue	\$70 USD
	1219-033 matte mint green	\$70 USD
	1219-401 platinum	\$70 USD
	1219-403 matte gold	\$70 USD



VETTORE

Sleek and modern wall-hung toilet with rimless design and minimalist seat.







1416-XXX-0129

Wall-Hung Toilet Bowl

14-1/4" x 21.5" x adjustable height 60.08 lbs

vitreous china; use with A0330-XXX seat only; in-wall tank sold separately
compatible with standard and flush models

	1416-001-0129 white	\$427 USD
	1416-014-0129 biscuit	\$470 USD
	1416-002-0129 matte white	\$534 USD
	1416-004-0129 matte black	\$534 USD
	1416-005-0129 black	\$534 USD







A0330-XXX

Soft-Close Toilet Seat

Ultra-slim with rounded front, 5 lbs

compatible with 1416-XXX-0129 toilet only

	A0330-001 white	\$178 USD
	A0330-014 biscuit	\$196 USD
	A0330-002 matte white	\$223 USD
	A0330-004 matte black	\$223 USD
	A0330-005 black	\$223 USD



BATHROOM COMFORT & CARE



Warm Touch

Soft-Touch surfaces stay looking warm to the touch and resist the coolness of metal



Hygienic

Soft-Touch surfaces stay deter the growth of bacteria and mildew



Superior grip

Soft-Touch surfaces provide a non-slip surface even when wet



No Rust/No Scratch

Soft-Touch surfaces resist scratching and rusting to stay looking like new



GRAB BARS

Made of seamless grade 304 stainless steel with hidden flange caps. Available in unique Soft-Touch finish and colors.







TBXX-XXX-1210

Swing-Up Grab Bar w/ Locking Mechanism

29-1/2" 5-7/8" 8.6 lbs

Features a locking mechanism to secure bar in the up position; White, Black and Orange colors feature unique Soft-Touch technology that stays warm to the touch

- | | | |
|---|-------------------------------|-----------|
|  | TBST-001-1210 white | \$160 USD |
|  | TBST-005-1210 black | \$160 USD |
|  | TBST-012-1210 orange | \$160 USD |
|  | TBPC-101-1210 stainless steel | \$167 USD |

SHOWER SEATS

Easy to clean phenolic shower seats fold up and away to save space. Capable of supporting up to 440 pounds.



TBDO-101-XXXX

Phenolic Folding Shower Seat

17-3/4" x 17-1/2" 13.45 lbs

Phenolic material is easy to clean and water and mildew resistant; stainless steel framing with hidden flange caps; folds up to save space when needed; supports up to 440 lbs

 TBDO-101-1004 white

\$303 USD

 TBDO-101-1005 oak

\$303 USD



BOCCHI®

KITCHEN DISPLAY UNITS

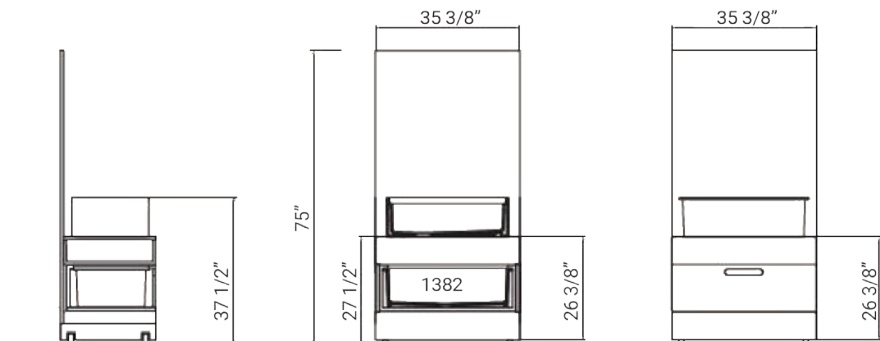

The top of the display unit has enough space to hold a 36" sink, and is on easy rolling casters with locking capability and anti-tip.

BOCCHI Kitchen Sink Display Units are made of solid wood construction. The **units** include both a printed panel at the back of the unit displaying a BOCCHI sink, and a drawer featuring an already-installed Sotto 32" undermount single bowl fireclay sink (1362-001-0120). The top of the display unit has enough space to hold a 36" sink, and is on easy rolling casters with locking capability and anti-tip. One apron-front sink of your choice may be selected for the top display and will receive an extra 50% off standard multiplier rates. The unit is shipped in a custom crate to ensure safe delivery.

A02-1362 Display Unit Wholesale Cost: \$600.00 NET (includes stand, undermount sink & shipping)

BOCCHI Faucet Display Units are made of solid wood construction and are pre-drilled to hold 5 faucets with easy lift-off tops for quick installation. Purchase of the display unit includes one each: Maggiore 2.0, Livenza 2.0, Lugano 2.0, Tronto 2.0 and Belsena 2.0 faucets (a full range of BOCCHI finishes including Chrome, Stainless Steel, Brushed Gold and Matte Black will be represented). Each unit is shipped in a custom crate to ensure safe delivery.

Faucet Display Unit Wholesale Cost: \$600.00 NET (includes stand, 5 faucets & shipping)



Show More / Save More: Showrooms with at least 3 kitchen or bathroom displays (either on a BOCCHI display unit, or installed in a custom display or vignette) may receive a FREE faucet tower display. Also, any showroom displaying a kitchen sink may select a free BOCCHI faucet, of their choice, to be displayed with the sink. Sinks not part of a display unit will be billed at the standard display discounts.

BOCCHI

KITCHEN DISPLAY UNITS

NEW GENERATION

Introducing BOCCHI's new and enhanced display units, designed to offer an immersive showcase of the unparalleled functionality, diverse installation styles, and exceptional durability and quality inherent in our fireclay and granite kitchen sink collections. Showcase the wide-range of BOCCHI kitchen sinks with their various installation types, features and colors. Units are built of solid-wood and feature anti-tip, easy-rolling casters and easy-glide drawers.

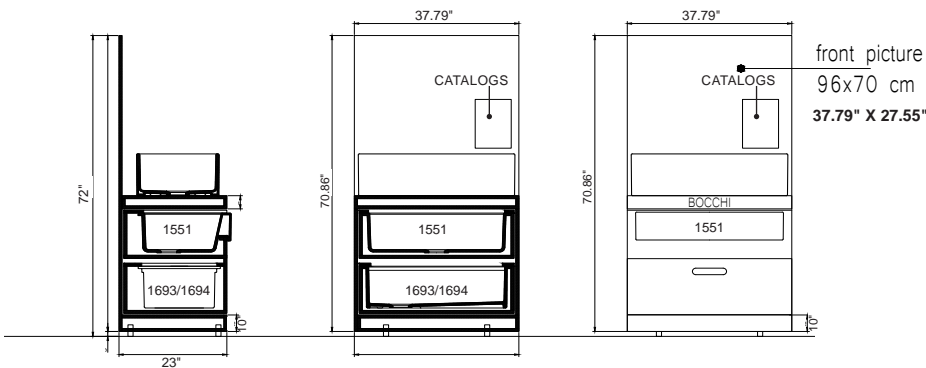

C-01 Fireclay Display Unit: Fits 3 sinks, you choose your colors... A) choose an apron sink of your choice for the top; B) a Nuova Pro short-front apron sink (1551); and C) a showroom exclusive Sotto Step-Rim undermount (1693 or 1694).

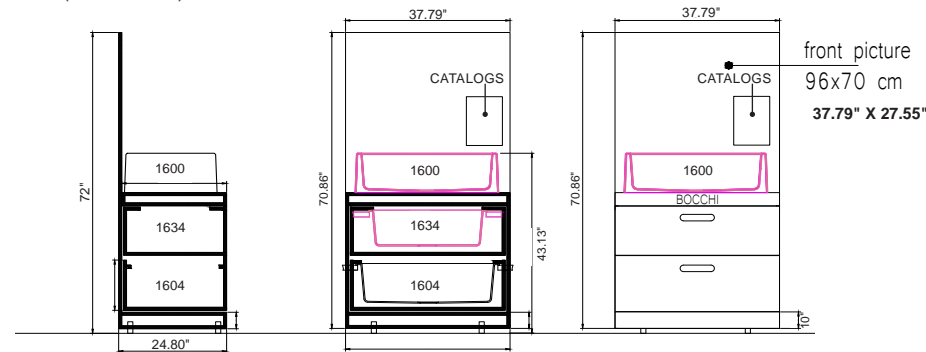

C-02 Granite Display Unit: Fits 3 sinks, you choose your colors... A) Arona Granite Apron Sink (1600) on the top (or a fireclay apron of your choice); B) Campino Uno (1634) in the center drawer; and C) larger Campino Uno (1604) in the bottom drawer.

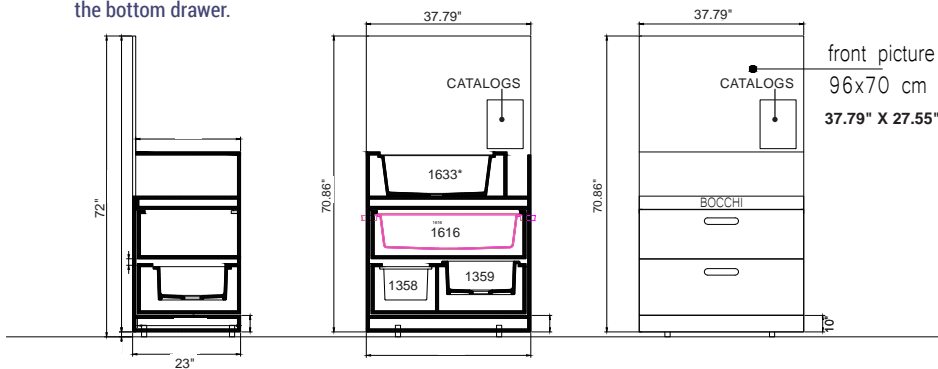

C-03 Baveno Display Unit: Fits 4 sinks, you choose your colors... A) Baveno Hide-Away (1633) and Move or Move+ faucet of your choice; B) Baveno Lux Hide-Away (1616) in the center; and C) one each of the Sotto bar sinks (1358 and 1359) *Top sink (1633) may be replaced with the larger 1695 Baveno sinks on request, subject to availability



C-01, C-02 and C-03 Display Units Wholesale Cost: \$900.00 NET (includes stand and shipping ONLY); Now you can choose your sink colors for each unit. Sinks are priced at display prices and ship for free if ordered at the same time as the matching unit.

DECO BALLS

Introducing BOCCHI Deco Balls: a sophisticated fusion of artistry and exclusivity. Adorned in BOCCHI's signature colors, these Deco Balls are hand-crafted by expert artisans.

Designed exclusively for display purposes, each orb serves as a captivating objet d'art, enhancing any space with their timeless elegance. The exclusive BOCCHI palette ensures a unique touch and harmonious blend of luxury and style. Let the exclusive BOCCHI colors redefine your display experience with these elegantly hand-crafted pieces.

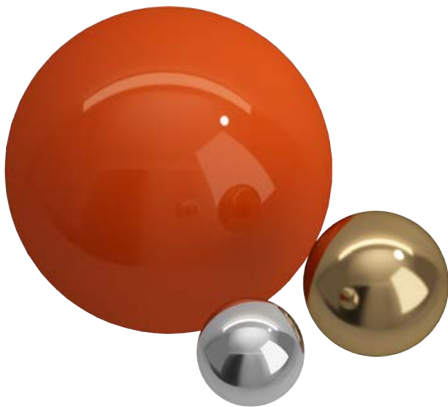

1264-XXX
Large Deco Ball
15.7 ø inches

\$100 USD
(all colors)

1297-XXX
Small Deco Ball
5.9 ø inches

\$70 USD
(all colors)

1263-XXX
Petite Deco Ball
3.9 ø inches

\$45 USD
(all colors)

Available Colors

- 001 white
- 014 biscuit
- 002 matte white
- 004 matte black
- 005 black
- 006 matte gray

- 010 sapphire blue
- 012 orange
- 029 matte ice blue
- 033 matte mint green
- 401 platinum
- 403 matte gold



TERMS & CONDITIONS OF SALE

Any BOCCHI price list is not an offer to sell to any company who possesses it, nor to anyone else, at the prices shown, BOCCHI reserves the right to accept or decline any order. Prices apply to BOCCHI (seller) plumbing products shown on-line at www.bocchiusa.com and in BOCCHI's product catalogs and other product literature. The prices in this price list supersede previous price lists and quotations, and are subject to change without notice. All prices are in U.S. dollars. These prices do not include freight or shipping to the customer.

TERMS & CONDITIONS OF SALE: The terms and conditions of sale set forth in the BOCCHI order confirmation or BOCCHI invoice shall constitute the entire agreement between Seller and Buyer with respect to the subject matter and supersedes all prior agreements, negotiations, understandings, representations and warranties, whether written, oral or otherwise, and may not be modified except in writing signed by the parties. For greater certainty, the language of any document used by Buyer to communicate its order of goods and terms or conditions that could be implied on the basis of trade custom, business efficacy or otherwise are expressly excluded. All proposals, negotiations, and purchase orders, if any, will be superseded by the BOCCHI sales order confirmation or BOCCHI invoice.

PRICES: All prices in the price list shall be superseded by Seller's prices in effect at the time of order entry, unless Seller has given a firm quotation in writing, and Buyer has given an order and the goods are released for shipment within the time periods specified in the quotation. Prices are (Incoterms 2000) ExWorks (origin) loaded unless otherwise noted. With respect to shipments for destinations outside of the United States, title to the goods remains with the Seller until such goods are discharged from the carrier to the Buyer in the destination country. Any freight charge related to a shipment to a Buyer will be invoiced by the freight company directly to the Buyer. Freight allowance, if any, is subject to Seller's then current freight terms. All prices listed and payments are to be in U.S. dollars.

CREDIT APPROVAL: Acceptance of orders, shipments, and deliveries shall at times be subject to the approval of the Sellers Credit Department, BOCCHI, Alpharetta, GA USA. Seller may at any time decline an order or decline to make any shipment or delivery except upon receipt of payment, or security, or upon terms and conditions satisfactory to BOCCHI. Seller reserves the right to ship C.O.D. or C.I.A.

TERMS OF PAYMENT: NET 30 from invoice date. A delinquency charge equal to the greater 18% per annum or the prime rate plus 1% as stated by Citibank USA (but in no event in excess of the maximum amount permitted by law), computed on the unpaid balance shall be paid on all accounts not paid in full when due. Interest shall be paid with Buyer's next remittance. In addition to the late payment charges, Buyer agrees to pay any and all collection costs, including reasonable attorney fees, incurred by Seller in collecting balances not paid within terms. Payments made by credit card are subject to 3% processing fee based on the net charged amount.

TAXES: Any taxes which Seller may be required to pay or collect, under any existing or future law, upon or with respect to the sale, delivery, storage, processing, use or consumption of any of the material conveyed, including taxes upon or measured by the receipts from the sale thereof, shall be for the account of the Buyer, who shall promptly pay the amount thereof to Seller upon demand. Where taxes do not apply upon sale or resale, Buyer shall provide Seller with appropriate exemption certificates, prior to the sale.

DESIGN CHANGES: Seller reserves the right to make revisions without notice in the design of its products or in their packaging.

DELAY: If any shipping dates have been specified, they are approximate and Seller shall not be bound thereby, but every effort will be made to ship in accordance with them. All shipments are subject to contingencies of manufacturer and other causes beyond Seller's control such as fires, strikes, delays in transportation, or governmental regulations.

CANCELLATION: Orders for modified, special order, certain colors or custom product, as well as those not listed in current price lists, may not be canceled or returned. Orders for all other product in current price list may be canceled if approved by BOCCHI and prior to shipment.

BUYER'S REMEDIES: If the goods furnished to the Buyer shall fail to conform to the contract or to any warranty, Seller shall replace such non-conforming goods at the original destination and shall furnish instructions for their disposition, provided Seller is notified of such non-conformity or defect within 60 days of shipment. The Buyer's exclusive and sole remedy on account or in respect of any breach of contract, or to any warranty, shall be to secure replacement thereof as aforesaid. Seller shall not be liable whether in contract or in Tort or under any other legal theory for loss of revenue, use or profit or for the cost of any labor expended on any such goods or for any special, incidental or consequential damages to anyone by reason of any breach of this contract or of any warranty.

WARRANTY: Seller's applicable respective limited warranty for the product in effect at the time of shipment shall apply. Buyer covenants and agrees that it will not remove any warranty, label, warning, tag, instruction, or manual from the goods and will ensure that all warranties, labels, warnings, tags, instructions, and manuals supplied with the goods or by Seller will be passed on to the ultimate user. The warranty supplied with the goods is Seller's sole and exclusive warranty. Except to the extent prohibited by applicable law, ANY IMPLIED WARRANTIES, INCLUDING WITHOUT LIMITATION MERCHANTABILITY AND FITNESS FOR A PARTICULAR PURPOSE ARE EXCLUDED FROM THIS CONTRACT AND SELLER AND ANY DISTRIBUTOR DISCLAIM ALL LIABILITY FOR SPECIAL, INCIDENTAL, OR CONSEQUENTIAL DAMAGES.

DAMAGE IN TRANSIT/STORAGE: Every reasonable precaution is taken against breakage or other damage in transit. As all goods are shipped (Incoterms 2000) ExWorks (origin) loaded unless otherwise noted. Seller's risk of loss ceases at the time goods are placed at Buyer's disposal. Claims against carriers are to be filed by the Buyer. It is the Buyer's responsibility to inspect products upon delivery for transit damage and/or shortage. If damage or shortage is detected, it should be duly noted on the bill of lading before signing for merchandise. An inspection report should be requested by the Buyer of the carrier, followed by a settlement claim to the carrier.

CHOICE OF LAW: Except as expressly provided herein, the contract is subject to all the provisions of the Uniform Commercial Code of the state of Seller's principal place of business without variation, exclusion or limitation as effective and in force on the contract date. The United Nations Convention on Contracts for the international Sales of Goods ("CISG") shall not apply. Seller hereby elects to opt out of the CISG.

INVOICE MINIMUM: An order for items included in this price list where the invoice price aggregate is less than \$50 net for products will be billed at \$50 net.

RETURNED MERCHANDISE: Merchandise which has been shipped according to Buyer's specifications cannot be returned for credit without prior written approval by Seller fully establishing the basis for the credit. Credit will be issued only for items which are found by Seller to be of standard manufacture and in salable condition. Return shipment is at Buyer's expense and risk. Buyer must prepay freight and will incur up to a 25% restocking charge when no manufacturing defects or errors are involved.

SHIPPING WEIGHTS: Shipping weights are approximate and are not guaranteed, buy are shown for customer convenience.

ELECTRONIC DATA INTERCHANGE (EDI): The terms and conditions for EDI transactions shall be the same as set forth herein. Each party shall, at its own expense, provide and maintain the equipment, software, services, and testing necessary to effectively and reliably transmit and receive documents. No document shall give rise to any obligation until it is accessible and able to be read by the receiving party at its computer.

There Terms of Conditions of Sale are subject to change without notice.

THANK YOU FOR CHOOSING BOCCHI

Thank you for choosing BOCCHI. By doing so, you will enjoy the outstanding quality and durability of your new BOCCHI product for many years to come. All information in this guide is based upon the latest product information at the time of publication. At BOCCHI, we strive to fulfill our mission of improving the level of luxurious living for each person who is touched by our products and services. We reserve the right to make changes in product characteristics, packaging, or availability at any time without notice.

Please take a few minutes to review this guide. Pay special attention to the care and cleaning instructions.

Proof of purchase (original sales receipt) must be provided to BOCCHI with all warranty claims from a valid BOCCHI vendor. BOCCHI is not responsible for labor charges, installation, or other incidental or consequential costs. In no event shall the liability of BOCCHI exceed the purchase price of the product.

FIRECLAY, VITREOUS CHINA and GRANITE KITCHEN AND BATHROOM FIXTURES LIFETIME LIMITED WARRANTY

BOCCHI warrants its fireclay fixtures, sinks, vitreous china toilet bowls, and granite sinks to be free of defects in material and workmanship during normal residential use for as long as the original consumer purchaser owns their home. Gloss reduction, scratching, staining, and acid or alkaline etching of the finish over time due to use, cleaning practices or water or atmospheric conditions are normal wear and tear. This warranty applies only to BOCCHI fireclay fixtures, sinks, vitreous china toilet bowls and granite sinks installed in the United States of America or Canada (North America). If a defect is found in normal residential use, BOCCHI will, at its election, repair, replace or make appropriate adjustment. Damage caused by accident, misuse, or abuse, such as cracks, chips and scratches after installation, is not covered by this warranty. Improper care and cleaning will void the warranty.

If the fireclay fixture, sink, vitreous china toilet bowl, or granite sink is used commercially, or

is installed outside of North America, BOCCHI warrants the product to be free from defects in material and workmanship for one (1) year from the date the product is installed, with all other terms of this warranty applying except duration. All other components other than the fireclay, vitreous china or granite carry BOCCHI's one-year limited warranty unless otherwise specified.

KITCHEN FAUCETS LIFETIME LIMITED WARRANTY

BOCCHI warrants all aspects of their faucets to be free of defects in material and workmanship during normal residential use for as long as the original consumer purchaser owns their home. This warranty applies only to BOCCHI faucets installed in North America. If a defect is found in normal residential use, BOCCHI will, at its election, repair, provide a replacement part or product, or make appropriate adjustment. Damage to a product caused by accident, misuse, or abuse is not covered by this warranty.*

If the faucet is used commercially, or is installed outside of North America, BOCCHI warrants the faucet to be free from defects in material and workmanship for one (1) year from the date the product is installed, under BOCCHI's standard one-year limited warranty.

KITCHEN SINK & FAUCET ACCESSORIES, GRAB BARS AND SHOWER SEATS ONE-YEAR LIMITED WARRANTY

BOCCHI warrants all aspects of the fixture, accessories such as cutting boards, colanders, drain covers, soap dispensers, grab bars, shower seats and other kitchen or bathroom accessories and workstation products ("Accessories") to be free of defects in material and workmanship during normal residential use for one year so long as the original consumer purchaser owns their home. This warranty applies only to BOCCHI Accessories installed in North America. If a defect is found in normal residential use, BOCCHI will, at its election, repair, provide a replacement part or product, or make appropriate adjustment. Damage to a

product caused by accident, misuse, or abuse is not covered by this warranty. Improper care and cleaning will void the warranty.*

If the Accessory is used commercially, or is installed outside of North America, BOCCHI warrants the Accessory to be free from defects in material and workmanship for one (1) year from the date the product is installed, under BOCCHI standard one-year limited warranty.

--

*DO NOT USE cleaners containing abrasive cleansers, ammonia, bleach, acids, waxes, alcohol, solvents or other products not recommended for chrome or stainless steel. This will void the warranty. DO NOT use drain unblocking products that involve filling sinks with chemicals.

THREE-YEAR LIMITED WARRANTY

BOCCHI warrants all aspects of their furniture to be free of defects in material and workmanship during normal residential use for three (3) years so long as the original consumer purchaser owns their home. This warranty applies only to BOCCHI bathroom furniture installed in North America. If a defect is found in normal residential use, BOCCHI will, at its election, repair, provide a replacement part or product, or make appropriate adjustment. Damage to a product caused by accident, misuse, or abuse is not covered by this warranty. Improper care and cleaning will void the warranty. * If the furniture is used to commercially, or is installed outside of North America, BOCCHI warrants the Furniture to be free from defects in material and workmanship for three (3) years from the date the product is installed, under BOCCHI standard 3-year limited warranty. **BOCCHI AND/OR SELLER ARE PROVIDING THIS WARRANTY IN LIEU OF ALL OTHER WARRANTIES, EXPRESSED OR IMPLIED, INCLUDING BUT NOT LIMITED TO THE IMPLIED WARRANTIES OF MERCHANTABILITY AND FITNESS FOR A PARTICULAR PURPOSE. BOCCHI AND/OR SELLER DISCLAIM ANY LIABILITY FOR SPECIAL, INCIDENTAL OR CONSEQUENTIAL DAMAGES.**

Some states/provinces do not allow limitations on how long an implied warranty lasts, or the exclusion or limitation of special, incidental or consequential damages, so these limitations and exclusions may

not apply to you. This warranty gives you specific legal rights. You may also have other rights which vary from state/province to state/province. This warranty is to the original consumer purchaser only, and excludes product damage due to installation error, product abuse, or product misuse, whether performed by a contractor, service company, or consumer. This is BOCCHI's exclusive written warranty.

GENERAL CARE AND CLEANING TIPS

For best results, keep the following in mind when caring for your product: Always test your cleaning solution on an inconspicuous area before applying it to the entire surface. Wipe surfaces clean and rinse completely with water immediately after applying cleanser. Rinse and dry any over-spray that lands on nearby surfaces. DO NOT allow cleansers to soak on surfaces. Use a soft, dampened sponge or cloth. NEVER use an abrasive material such as a harsh brush or scouring pad to clean any BOCCHI surface. Success with cleaners and procedures is dependent upon such factors as the hardness and temperature of the water, exact measurements of ingredients, changes in cleaning formulas and the condition of the product being cleaned. Since there are variations within these factors, BOCCHI cannot guarantee the effectiveness of the formulas mentioned.

Care & Cleaning Tips for Fireclay and Vitreous China: Rinse thoroughly and use a soft cloth to wipe the product dry after each use. Soft abrasive cleaners may be used when necessary to clean BOCCHI fireclay and vitreous china fixtures. Strong abrasive cleaners should NEVER be used and may scratch or dull the surface. The appearance of surface marks and build-up of rust or other stains, minerals, etc. on the surface may be easily removed using recommended cleansers such as Bar Keepers Friend.

Care & Cleaning Tips for Granite: Rinse thoroughly and use a soft cloth to wipe the product dry after each use. Soft abrasive cleaners may be used when necessary to clean, strong abrasive cleaners should NEVER be used.

To prevent limescale build-up leave a solution of warm water and white vinegar or a specific descaling/anti-

limescale product for use with granite sinks, on the sink bottom for a few hours (or as directed)—then rub vigorously with a non-abrasive sponge until clean and rinse and dry sink.

Care & Cleaning Tips for Faucets, Soap Dispensers, Chrome and Other Metal Surfaces: DO NOT use cleansers containing ammonia, bleach or acid. Rinse thoroughly and use a soft cloth to wipe the product dry after each use. The ideal cleaning technique is to always blot dry any water from metal surfaces. Allowing water to evaporate on metal will form water deposits. It is important to use a dabbing action to dry metal, NOT an abrasive or rubbing action. Cleaning with a damp sponge or cloth and buff drying should keep your product looking beautiful.

Care & Cleaning Tips for Sink Accessories: Non-wood accessories may be cleaned using standard dish soap, or be washed in a dishwasher. It is important to thoroughly dry after each wash to maintain the

best finish to each surface. Wood accessories should be thoroughly washed and dried after each use and never stored wet to prevent warping. Occasional application of a thin coating of food-grade oil to the wood surfaces will prevent them from drying out. Be sure to wipe off any excess oil after application.

Care & Cleaning Tips for Bathroom Furniture: To maintain your bathroom furniture, use a soft, damp cloth for gentle cleaning. After cleaning the wood surfaces, ensure thorough drying. Opt for mild cleaning materials or soapy water, while avoiding abrasive and acidic cleaners: test on an unexposed area before using. Be careful to prevent contact with extreme heats from styling tools etc. Avoid exposure to extreme temperatures and intense sunlight to prevent damage. Avoid moisture buildup to prolong the furniture's lifespan.

[See more cleaning & care tips on-line](#)

WWW.BOCCHIUSA.COM

KITCHEN PRODUCTS NUMERICAL BY CODE

INDEX: BY CODE

1136-XXX-0120 ... (Classico) ... page 17	2025 0001 XX ... (Lugano 2.0) ... page 61
1137-XXX-0120 ... (Classico) ... page 17	2026 0001 XX ... (Tronto 2.0) ... page 61
1138-XXX-0120 ... (Classico) ... page 17	2027 0001 XX ... (Baveno Pro) ... page 62
1139-XXX-0120 ... (Classico) ... page 16	2028 0001 XX ... (Baveno Duo) ... page 62
1220 0XX ... (Luxury Drain Cover) ... page 65	2029 0001 XX ... (Baveno Move) ... page 63
1344-XXX-0120...(Contempo Step-Rim)...page21	2030 0001 XX ... (Baveno Move+) ... page 63
1346-XXX-0120 ... (Contempo) ... page 19	2180 0003 XX ... (Deck Plate) ... page 64
1348-XXX-0120...(Contempo Step-Rim)...page20	2180 0004 XX ... (Deck Plate) ... page 64
1350-XXX-0120 ... (Contempo) ... page 18	2300 20XX ... (Sink Grid 2.0) ... page 76-77
1352-XXX-0120 ... (Contempo) ... page 19	2310 0003 ... (Colander) ... page 69
1353-XXX-0120 ... (Vigneto) ... page 26	2310 0004 ... (Colander) ... page 69
1354-XXX-0120 ... (Contempo) ... page 19	2310 0005 ... (Colander) ... page 69
1356-XXX-0120 ... (Contempo) ... page 19	2310 0006 ... (Colander) ... page 69
1358-XXX-0120 ... (Sotto) ... page 35	2310 0007 ... (Colander) ... page 69
1359-XXX-0120 ... (Sotto) ... page 34	2310 0008 ... (Colander) ... page 69
1360-XXX-0120 ... (Sotto) ... page 33	2320 0001 ... (Cutting Board) ... page 70
1361-XXX-0120 ... (Sotto) ... page 35	2320 0003 ... (Cutting Board) ... page 70
1362-XXX-0120 ... (Sotto) ... page 32	2320 0004 ... (Cutting Board) ... page 70
1481-XXX-0120 ... (Aderci) ... page 15	2320 0005 ... (Cutting Board) ... page 70
1500-XXX-0127 ... (Nuova) ... page 22	2320 0006 ... (Cutting Board) ... page 70
1501-XXX-0127 ... (Nuova) ... page 23	2320 0007 ... (Cutting Board) ... page 70
1504-XXX-0120...(Contempo Step-Rim)...page21	2320 0008 ... (Prep Board) ... page 70
1505-XXX-0120...(Contempo Step-Rim)...page21	2320 0009 ... (Prep Board) ... page 70
1551-XXX-0120 ... (Nuova Pro) ... page 24	2320 0010 ... (Prep Board) ... page 70
1600-XXX-0120 ... (Arona Step-Rim) ... page 45	2320 0011 ... (Prep Board) ... page 70
1602-XXX-0126 ... (Campino) ... page 48	2320 0012 ... (Prep Board) ... page 70
1604-XXX-0126 ... (Campino) ... page 49	2320 0013 ... (Prep Board) ... page 70
1606-XXX-0126 ... (Campino) ... page 49	2320 0014 ... (Prep Board) ... page 71
1608-XXX-0126 ... (Campino) ... page 49	2320 0015 ... (Prep Board) ... page 71
1616-XXX-0126 ... (Baveno) ... page 52, 53	2320 0016 ... (Cutting Board) ... page 71
1618-XXX-0126 ... (Baveno Lux) ... page 54	2320 0019 ... (Cutting Board) ... page 71
1627-XXX-0120 ... (Sotto) ... page 33	
1628-XXX-0120...(Contempo Step-Rim)...page21	2330 0001 XX ... (Strainer) ... page 65
1633-XXX-012X ... (Baveno) ...page 38,39	
1634-XXX-0126 ... (Campino) ... page 49	2340 0005 XX ... (Soap Dispenser) ... page 64
1635-XXX-0120 ... (Levanzo) ... page 57	2340 0006 XX ... (Soap Dispenser) ... page 64
1693-XXX-0120 ... (Sotto Step-Rim) ... page 30	2340 0007 XX ... (Soap Dispenser) ... page 65
1694-XXX-0120 ... (Sotto Step-Rim) ... page 31	2350 0001 ... (Roller Mat) ... page 71
1695-XXX-012X ... (Bevono) ... page 39	
2019 0001 XX ... (Maggiore 2.0) ... page 61	
2020 0001 XX ... (Livenza 2.0) ... page 61	
2023 0001 XX ... (Belsena 2.0) ... page 60	
2024 0001 XX ... (Pagano 2.0) ... page 60	

KITCHEN PRODUCTS NUMERICAL BY CODE

2350 0003 ... (Roller Mat) ... page 71	2370 0001 ...(Access. Bundle)... page 72
2350 0004 ... (Roller Mat) ... page 71	2370 0002 ...(Access. Bundle)... page 72
2350 0005 ... (Roller Mat) ... page 71	2370 0003 ...(Access. Bundle)... page 72
2360 XXXX ... (Touch-Up Glaze) ... page 65	2370 0004 ...(Access. Bundle)... page 72

BATHROOM PRODUCTS NUMERICAL BY CODE

1002-XXX-0320 ... (Taormina) ... page 114	1418-XXX-0126 ... (Milano) ... page 96
1003-XXX-0038 ... (Taormina) ... page 114	1419-XXX-0126 ... (Milano) ... page 96
1006-XXX-0125 ... (Scala) ... page 104	1470-XXX-0126 ... (Sottile) ... page 108
1007-XXX-012X ... (Taormina) ... page 114	1471-XXX-0125 ... (Sottile) ... page 108
1008-XXX-012X ... (Taormina) ... page 114	1476-XXX-0125 ... (Sottile) ... page 110
1074-XXX-0126 ... (Firenze) ... page 86	1477-XXX-0125 ... (Sottile) ... page 110
1075-XXX-0125 ... (Etna) ... page 81	1478-XXX-0125 ... (Sottile) ... page 110
1076-XXX-0126 ... (Scala Arch) ... page 105	1479-XXX-0126 ... (Sottile) ... page 110
1077-XXX-012X ... (Scala Arch) ... page 105	1489-XXX-0126 ... (Fenice) ... page 84
1078-XXX-012X ... (Scala Arch) ... page 106	1490-XXX-0126 ... (Fenice) ... page 84
1079-XXX-012X ... (Scala Arch) ... page 106	1494-XXX-0125 ... (Sottile) ... page 112
1105-XXX-012X ... (Ravenna) ... page 100	1521-XXX-0125 ... (Sottile) ... page 112
1111-XXX-0132 ... (Ravenna) ... page 101	1598-XXX-0126 ... (Sottile) ... page 112
1113-XXX-012X ... (Ravenna) ... page 100	1599-XXX-0126 ... (Sottile) ... page 112
1114-XXX-0125 ... (Etna) ... page 81	1600-XXX-0126 ... (Sottile) ... page 113
1115-XXX-0125 ... (Etna) ... page 81	1632-XXX-0129 ... (Milano) ... page 94
1120-XXX-0125 ... (Venezia) ... page 116	
1122-XXX-0126 ... (Parma) ... page 98	3930 0001 ... (Metal Console Legs) ... pages 84, 88, 92, 98, 101 and 106
1123-XXX-012X ... (Parma) ... page 98	
1124-XXX-012X ... (Parma) ... page 98	
1161-XXX-012X ... (Ravenna) ... page 100	7006-XXXX-1077 ... (Scala Arch) ... page 106
1162-XXX-0125 ... (Etna) ... page 82	7006-XXXX-1079 ... (Scala Arch) ... page 106
1168-XXX-0127 ... (Lavita) ... page 88	7008-XXXX-1490 ... (Fenice) ... page 84
1169-XXX-0320 ... (Lavita) ... page 88	7019-XXXX-1105 ... (Ravenna) ... page 102
1219-XXX ... (Pop-Up Drain Cover) ... page 108,116	7019-XXXX-1161 ... (Ravenna) ... page 102
1304-XXX-0129 ... (Firenze) ... page 86	7020-XXXX-1418 ... (Milano) ... page 96
1376-XXX-012X ... (Milano) ... page 90	7020-XXXX-1419 ... (Milano) ... page 96
1377-XXX-012X ... (Milano) ... page 90	7712-XXXX-1162 ... (Etna) ... page 82
1378-XXX-012X ... (Milano) ... page 90	
1384-XXX-0125 ... (Parma) ... page 99	A0330-XXX ... (Vettore) ... page 118
1392-XXX-0126 ... (Milano) ... page 94	A0332-XXX ... (Firenze) ... page 86
1393-XXX-0132 ... (Milano) ... page 92	A0337-XXX ... (Milano) ... page 94
1394-XXX-012X ... (Milano) ... page 92	
1416-XXX-0129 ... (Vettore) ... page 118	TBDO-101-XXXX ... (Shower Seat) ... page 123
	TBXX-XXX-1210 ... (Grab Bar) ... page 122

PRODUCTS BY TYPE

BATHROOM CABINET/FURNITURE BASES

7006-XXXX-1077 ... (Scala Arch) ...	page	106
7006-XXXX-1079 ... (Scala Arch) ...	page	106
7008-XXXX-1490 ... (Fenice) ...	page	84
7019-XXXX-1105 ... (Ravenna) ...	page	102
7019-XXXX-1161 ... (Ravenna) ...	page	102
7020-XXXX-1418 ... (Milano) ...	page	96
7020-XXXX-1419 ... (Milano) ...	page	96
7712-XXXX-1162 ... (Etna Bench) ...	page	72

BATHROOM CONSOLE LEGS

1169-XXX-0320 ... (Lavita) ...	page	88
3930 0001 ... (Metal Console Legs) ...	pages 84, 88, 92, 98, 101 and 106	

BATHROOM GRAB BARS

TBXX-XXX-1210 ... (Grab Bar) ...	page	122
----------------------------------	------	-----

BATHROOM PEDESTAL SINKS

1007-XXX-012X ... (Taormina) ...	page	114
1008-XXX-012X ... (Taormina) ...	page	114
1075-XXX-0125 ... (Etna) ...	page	81

BATHROOM PEDESTAL BASES

1002-XXX-0320 ... (Taormina) ...	page	114
----------------------------------	------	-----

BATHROOM SHOWER SEATS

TBDO-101-XXXX ... (Shower Seat) ...	page	123
-------------------------------------	------	-----

BATHROOM SINKS (Wall-Hung or Counter)

1076-XXX-0126 ... (Scala Arch) ...	page	105
1077-XXX-012X ... (Scala Arch) ...	page	105
1078-XXX-012X ... (Scala Arch) ...	page	106
1079-XXX-012X ... (Scala Arch) ...	page	106
1105-XXX-012X ... (Ravenna) ...	page	100
1111-XXX-0132 ... (Ravenna) ...	page	101
1113-XXX-012X ... (Ravenna) ...	page	100
1115-XXX-0125 ... (Etna) ...	page	81
1122-XXX-0126 ... (Parma) ...	page	98
1123-XXX-012X ... (Parma) ...	page	98
1124-XXX-012X ... (Parma) ...	page	98
1161-XXX-012X ... (Ravenna) ...	page	100
1168-XXX-0127 ... (Lavita) ...	page	88

1376-XXX-012X ... (Milano) ...	page	90
1377-XXX-012X ... (Milano) ...	page	90
1378-XXX-012X ... (Milano) ...	page	90
1392-XXX-0126 ... (Milano) ...	page	94
1393-XXX-0132 ... (Milano) ...	page	92
1394-XXX-012X ... (Milano) ...	page	92
1418-XXX-0126 ... (Milano) ...	page	96
1419-XXX-0126 ... (Milano) ...	page	96

BATHROOM TRAP COVERS

1003-XXX-0038 ... (Taormina) ...	page	114
----------------------------------	------	-----

BATHROOM TOILETS and TOILET SEATS

1304-XXX-0129 ... (Firenze) ...	page	86
1416-XXX-0129 ... (Vettore) ...	page	118
1632-XXX-0129 ... (Milano) ...	page	94
A0330-XXX ... (Vettore) ...	page	118
A0332-XXX ... (Firenze) ...	page	86
A0337-XXX ... (Milano) ...	page	94

BATHROOM UNDERMOUNT SINKS

1006-XXX-0125 ... (Scala) ...	page	104
1384-XXX-0125 ... (Parma) ...	page	99

BATHROOM VESSEL SINKS

1074-XXX-0126 ... (Firenze) ...	page	86
1114-XXX-0125 ... (Etna) ...	page	81
1120-XXX-0125 ... (Venezia) ...	page	116
1162-XXX-0125 ... (Etna) ...	page	82
1470-XXX-0126 ... (Sottile) ...	page	108
1471-XXX-0125 ... (Sottile) ...	page	108
1476-XXX-0125 ... (Sottile) ...	page	110
1477-XXX-0125 ... (Sottile) ...	page	110
1478-XXX-0125 ... (Sottile) ...	page	110
1479-XXX-0126 ... (Sottile) ...	page	110
1489-XXX-0126 ... (Fenice) ...	page	84
1490-XXX-0126 ... (Fenice) ...	page	84
1494-XXX-0125 ... (Sottile) ...	page	112
1521-XXX-0125 ... (Sottile) ...	page	112
1598-XXX-0126 ... (Sottile) ...	page	112
1599-XXX-0126 ... (Sottile) ...	page	112
1600-XXX-0126 ... (Sottile) ...	page	113

PRODUCTS BY TYPE

KITCHEN APRON-FRONT SINKS

1136-XXX-0120	...	(Classico)	...	page	17
1137-XXX-0120	...	(Classico)	...	page	17
1138-XXX-0120	...	(Classico)	...	page	17
1139-XXX-0120	...	(Classico)	...	page	16
1344-XXX-0120	...	(Contempo Step-Rim)	...	page	21
1346-XXX-0120	...	(Contempo)	...	page	19
1348-XXX-0120	...	(Contempo Step-Rim)	...	page	20
1350-XXX-0120	...	(Contempo)	...	page	18
1352-XXX-0120	...	(Contempo)	...	page	19
1353-XXX-0120	...	(Vigneto)	...	page	26
1354-XXX-0120	...	(Contempo)	...	page	19
1356-XXX-0120	...	(Contempo)	...	page	19
1481-XXX-0120	...	(Aderci)	...	page	15
1500-XXX-0127	...	(Nuova)	...	page	22
1501-XXX-0127	...	(Nuova)	...	page	23
1504-XXX-0120	...	(Contempo Step-Rim)	...	page	21
1505-XXX-0120	...	(Contempo Step-Rim)	...	page	21
1551-XXX-0120	...	(Nuova Pro)	...	page	24
1600-XXX-0120	...	(Arona)	...	page	45
1628-XXX-0120	...	(Contempo Step-Rim)	...	page	21

KITCHEN COLANDERS

2310 0003	...	(Colander)	...	page	69
2310 0004	...	(Colander)	...	page	69
2310 0005	...	(Colander)	...	page	69
2310 0006	...	(Colander)	...	page	69
2310 0007	...	(Colander)	...	page	69
2310 0008	...	(Colander)	...	page	69

KITCHEN CUTTING BOARDS

2320 0001	...	(Cutting Board)	...	page	70
2320 0003	...	(Cutting Board)	...	page	70
2320 0004	...	(Cutting Board)	...	page	70
2320 0005	...	(Cutting Board)	...	page	70
2320 0006	...	(Cutting Board)	...	page	70
2320 0007	...	(Cutting Board)	...	page	70
2320 0016	...	(Cutting Board)	...	page	71
2320 0019	...	(Cutting Board)	...	page	71

KITCHEN DECK PLATES

2180 0003 XX	...	(Deck Plate)	...	page	64
2180 0004 XX	...	(Deck Plate)	...	page	64

KITCHEN DROP-IN/UNDERMOUNT SINKS

1358-XXX-0120	...	(Sotto)	...	page	35
1359-XXX-0120	...	(Sotto)	...	page	34
1360-XXX-0120	...	(Sotto)	...	page	33
1361-XXX-0120	...	(Sotto)	...	page	35
1362-XXX-0120	...	(Sotto)	...	page	32
1500-XXX-0127	...	(Nuova)	...	page	23
1501-XXX-0127	...	(Nuova)	...	page	23
1551-XXX-0120	...	(Nuova Pro)	...	page	24
1602-XXX-0126	...	(Campino)	...	page	48
1604-XXX-0126	...	(Campino)	...	page	49
1606-XXX-0126	...	(Campino)	...	page	49
1608-XXX-0126	...	(Campino)	...	page	49
1616-XXX-0126	...	(Baveno)	...	page	52-53
1618-XXX-0126	...	(Baveno)	...	page	54
1627-XXX-0120	...	(Sotto)	...	page	33
1633-XXX-012X	...	(Baveno)	...	page	38-39
1634-XXX-0126	...	(Campino)	...	page	49
1635-XXX-0120	...	(Levanzo)	...	page	57
1693-XXX-0120	...	(Sotto Step-Rim)	...	page	30
1694-XXX-0120	...	(Sotto Step-Rim)	...	page	31
1695-XXX-01XX	...	(Baveno)	...	page	39

KITCHEN FAUCETS

2019 0001 XX	...	(Maggiore 2.0)	...	page	61
2020 0001 XX	...	(Livenza 2.0)	...	page	61
2023 0001 XX	...	(Belsena 2.0)	...	page	60
2024 0001 XX	...	(Pagano 2.0)	...	page	60
2025 0001 XX	...	(Lugano 2.0)	...	page	61
2026 0001 XX	...	(Tronto 2.0)	...	page	61
2027 0001 XX	...	(Baveno Pro)	...	page	62
2028 0001 XX	...	(Baveno Duo)	...	page	62
2029 0001 XX	...	(Baveno Move)	...	page	63
2030 0001 XX	...	(Baveno Move+)	...	page	63

PRODUCTS BY TYPE

KITCHEN PREP BOARDS (cont.)

2320	0008	...	(Prep Board)	...	page	70
2320	0009	...	(Prep Board)	...	page	70
2320	0010	...	(Prep Board)	...	page	70
2320	0011	...	(Prep Board)	...	page	70
2320	0012	...	(Prep Board)	...	page	70
2320	0013	...	(Prep Board)	...	page	70
2320	0014	...	(Prep Board)	...	page	71
2320	0015	...	(Prep Board)	...	page	71

KITCHEN RETRO-FIT APRON SINKS

1500-XXX-0127	...	(Nuova)	...	page	22
1501-XXX-0127	...	(Nuova)	...	page	23
1551-XXX-0120	...	(Nuova Pro)	...	page	24

KITCHEN ROLLER MATS

2350	0001	...	(Roller Mat)	...	page	71
2350	0003	...	(Roller Mat)	...	page	71
2350	0004	...	(Roller Mat)	...	page	71
2350	0005	...	(Roller Mat)	...	page	71

KITCHEN SINK GRIDS

2300	20XX	...	(Sink Grid 2.0)	...	page	76-77
------	------	-----	-----------------	-----	------	-------

KITCHEN SOAP DISPENSERS

2340	0005	XX	...	(Soap Dispenser)	...	page	64
2340	0006	XX	...	(Soap Dispenser)	...	page	64
2340	0007	XX	...	(Soap Dispenser)	...	page	65

KITCHEN STRAINERS & DRAIN COVERS

1220	0XX	...	(Luxury Drain Cover)	...	page	65	
2330	0001	XX	...	(Strainer)	...	page	47

KITCHEN TOUCH-UP GLAZE

2360	XXXX	...	(Touch-Up Glaze)	...	page	65
------	------	-----	------------------	-----	------	----





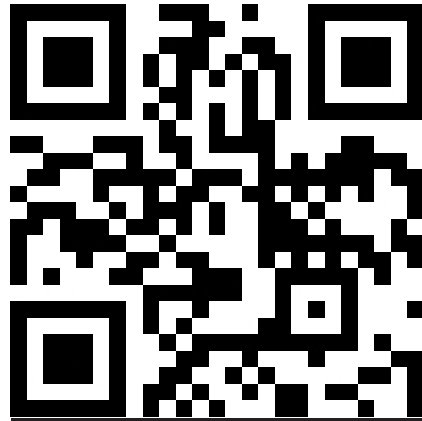

scan for more



follow us on instagram
@bocchiusa

BOCCHI

6590 Shiloh Rd East, Suite D
Alpharetta, GA 30005

t. 678-878-3771

t. 877-565-2221

info@bocchiusa.com

www.bocchiusa.com

01.2024 v1